

***GRANDEG***

*Turbo*

**SERIES FULLY AUTOMATIC  
PELLET HEATING BOILERS**



# **OPERATION AND INSTALLATION MANUAL**



**Please read carefully the entire Operation and Installation Manual before installing and operating your boiler. Please remember, that your boiler must be commissioned by a GRANDEG certified service specialist. Failure to observe the guidelines set out in this Operation and Installation Manual may invalidate your warranty.**

## **Content**

1. Introduction
2. General Information

- Turbo Pellet Heating Boiler Components
- Turbo Pellet Heating Boiler Key Features
- Safety Guidelines
- Signage on the Boiler
- Fuel Recommendations

4. User Information

- Commissioning
- Boiler Operation Process
- Boiler Control System
- Boiler Maintenance

5. Installation Information

- Installation Requirements
- Technical Data
- Recommended Connection Schematics
- Installation Process
- Recommendations for Flue Pipe Installation

6. Warranty Terms
7. Appendices

- Annual Maintenance Form
- Notes on Performed Annual Maintenance
- Cleaning Log
- Warranty Certificate

## **Introduction**

### **Dear Customer,**

The GRANDEG pellet heating boiler is developed so as to ensure warmth and comfort both during your everyday work time and leisure.

The technologies of GRANDEG boilers have been worked out so that the boilers would operate with a wide range of biological fuel material, which is prepared in the form of pellets. In this way, you obtain the maximum usage efficiency of biological fuel material, and correspondingly lower heating costs.

In order for the GRANDEG boiler to serve for a long time and reliably, the following three conditions have to be met:

- 1) follow the terms defining proper operation of the boiler;
- 2) follow the terms of warranty of the boiler;
- 3) have the boiler serviced by service specialists that have been trained and certified by GRANDEG.

Our experience shows that a properly installed, serviced and operated boiler will serve protractedly and reliably. This is confirmed by positive customer feedback over many years. We therefore hope that you will also follow the terms described in this Operation and Installation Manual.

GRANDEG is continuously working on the construction of the boiler and optimization of its appearance, therefore some changes that do not affect the technical characteristics may not be depicted in the Operation and Installation Manual. We will be happy to receive your suggestions and recommendations on how to improve the operation of the boiler.

With warm wishes,



Andris Lubiņš  
Founder of GRANDEG

## **General Information**

This fully automated pellet heating boiler is intended for heating domestic houses and industrial and commercial spaces. Boiler plate with information on technical data of the boiler is located at the rear of the boiler. The unique boiler construction guarantees efficient combustion and heat exchange (coefficients of performance: 93% for combustion and 93% for heat exchange). Heating boiler is equipped with automatic ignition, self-cleaning pellet burner and self-cleaning heat exchanger. Boiler control system, with the help of built-in oxygen sensor (lambda probe), precisely regulates the amount of air necessary for efficient and economic combustion of different wood and biomass pellets.

Turbo series pellet heating boilers with output of 200, 300 and 500kw are equipped with ladder for convenient access to vertical heat exchanger tubes during maintenance.

Pellet hopper may be fed manually (capacity of the largest pellet hopper is 600kg) or automatically via pneumatic pellet transportation system that ensures regular pellet supply from the pellet storage container (silo) to the pellet hopper.

To achieve a higher heat output, boiler may be connected to several pellet heating boilers in parallel connection as well as alternative heating sources (heat pumps, solar panels) and other types of heating boilers (gas, diesel).

Pellet heating boiler may be additionally equipped with: pneumatic pellet transportation system *Pneimo*, pellet storage container *Silo* and the following boiler control system options:

- Management and control by internet and/or texting
- Cascade management of several boilers
- Home and away
- Hot water preparation (single loop)
- Management of two separate heating loops
- Solar panel management

The following standards have been applied in boiler design and construction: LVS EN 12953-1, EN 303-5, ISO 12100:2010, Directive 97/23/EC.

## Turbo Pellet Heating Boiler Components

This pellet heating boiler consists of 2 parts – a water heating boiler and a pellet hopper. Boiler body (1) is a welded construction made of high quality 4-6 mm thick steel sheets. Boiler body is covered with removable decorative siding with heat insulation underneath. Boiler body consists of a burning chamber with a pellet burner underneath. A heat exchanger with vertical heat exchange tubes as well as a flue gas collector and a connection for the flue pipe are located in the upper part of the boiler (6)

Pellet hopper (10) and pellet supply mechanism with combustion (air) fans may be located to the right or to the left from the heating boiler, depending on requirements of the customer. Pellet hopper is installed above pellet supply mechanism (9), next to the heating boiler. A pellet hopper of a larger size may be located in adjoining room. A part of this room also may be used to store pellets. In those cases it is necessary to install a screw feeder or pneumatic pellet transportation system to transport pellets from pellet storage to the pellet hopper.

The following doors and hatches are intended for boiler cleaning and maintenance:

- in the upper part of the boiler (2) – for cleaning heat exchanger tubes,
- in front (4) and on both sides of the boiler (7) – for cleaning out ash,
- at the bottom of the boiler flue pipe (13) – for cleaning out ash.

Heating Boiler is started up and controlled via control panel (8).

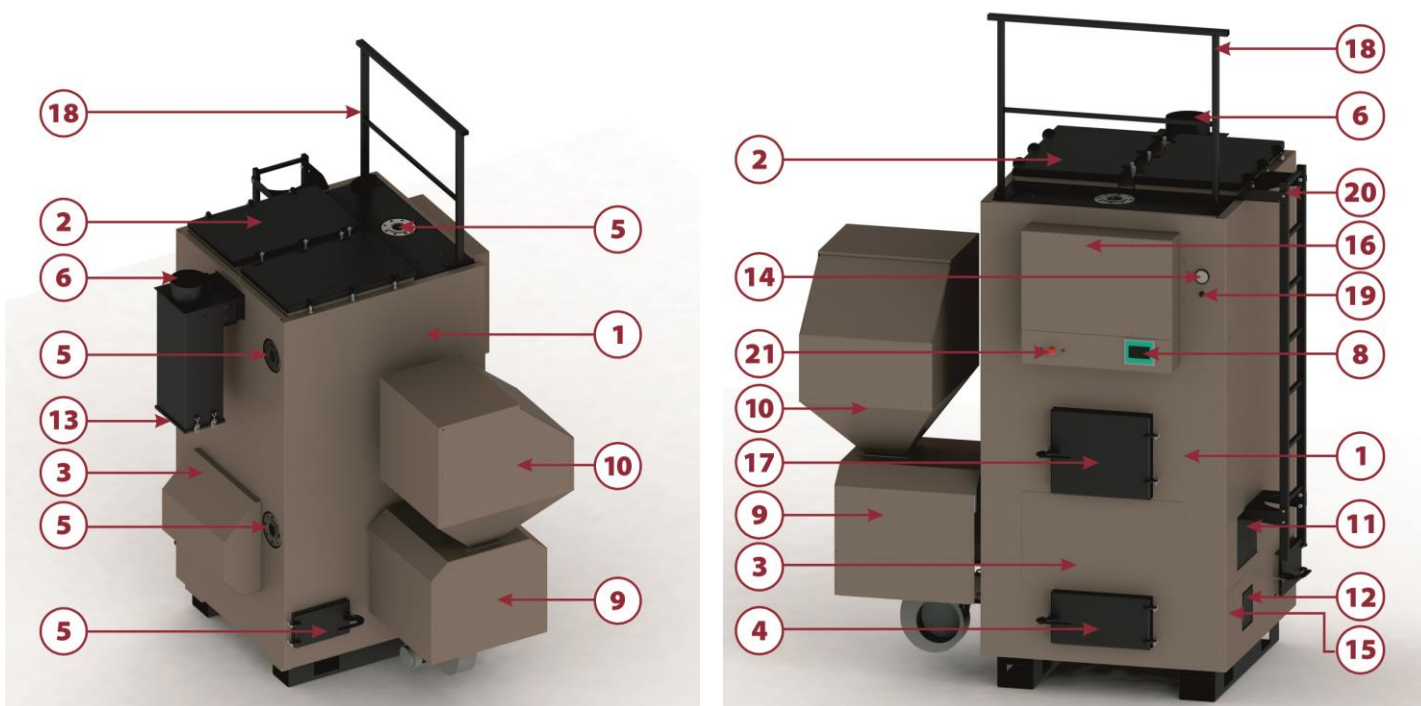

# **OPERATION AND INSTALLATION MANUAL**

<b>Designations:</b>			
1.	Boiler body	11.	Connection flange for pellet supply mechanism
2.	Heat exchanger cleaning doors	12.	Connection flange for combustion (air) fan
3.	Decorative siding	13.	Flue pipe cleaning hatch
4.	Ash compartment cleaning door (front)	14.	Thermo manometer
5.	Connections to the heating system	15.	Connection flange for pellet supply mechanism combustion (air) fan and motor
6.	Boiler flue starting collar	16.	Boiler control box
7.	Ash compartment cleaning doors (in both sides)	17.	Burning chamber doors
8.	Control panel	18.	Handrail
9.	Protective siding for the pellet supply mechanism	19.	Emergency Stop button (power supply cut)
10.	Pellet hopper	20.	Ladder
21.	Overheat protection automatic switch		

## **Turbo Pellet Heating Boiler Key Features**

### **Self-cleaning Heat Exchanger**

This pellet heating boiler is specially designed with a small burning chamber and large self-cleaning heat exchanger with vertical tubes for effective heat transfer. Built-in static metal blades increase the overall heat exchanger surface and ensure self-cleaning of tubes, due to the turbulence of flue gasses.

### **Self-cleaning Pellet Burner**

Vertical self-cleaning pellet burner is specially designed to achieve complete combustion of fuel and is equipped with automatic ignition. To increase combustion efficiency, pellet burner is fitted with primary and secondary air supply in the pellet burning area. The periodic self-cleaning of the pellet burner is managed by boiler control system. During the cleaning stage of the burner, cleaning bolts beneath the burner are opening and closing. Cleaning intervals depend on pellet burner cleaning mode settings (poor quality pellets will require more frequent cleaning intervals).

# OPERATION AND INSTALLATION MANUAL

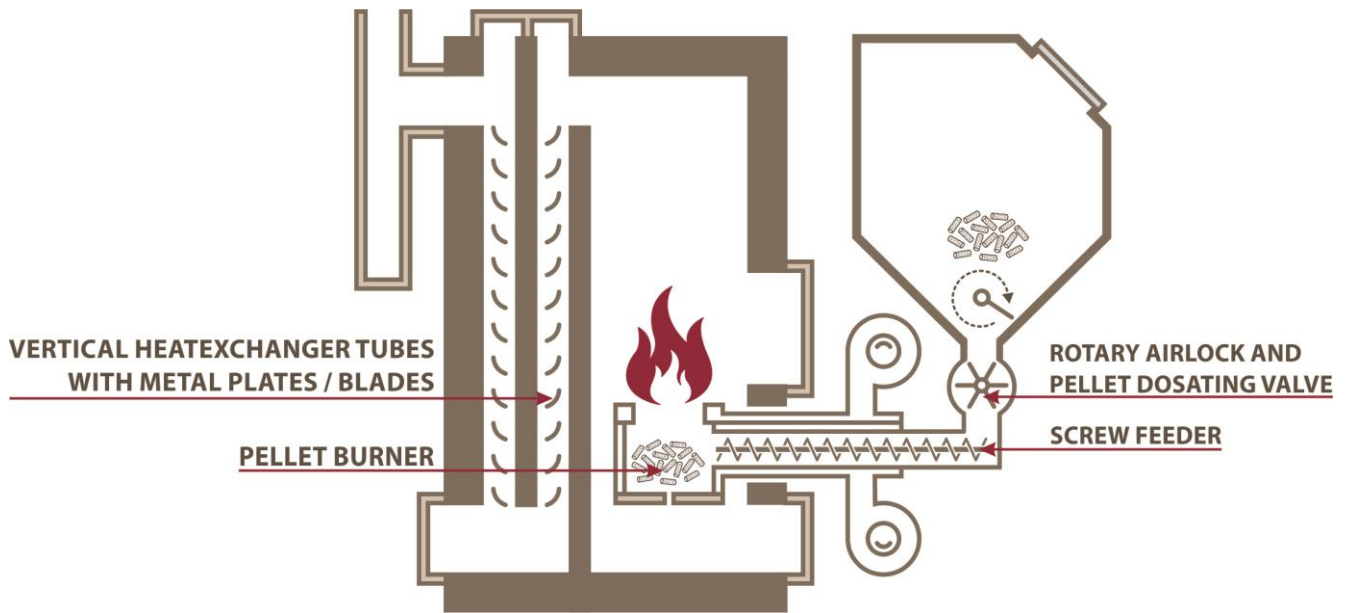

## Two-step Pellet Supply Mechanism

A two-step pellet supply mechanism is located directly beneath the pellet hopper. It consists of a rotary airlock and pellet dosating valve and a screw feeder, which transports pellets further into the pellet burning area.

Rotary airlock and pellet dosating valve ensures an equable and smooth dosage of pellets and protects against potential back burn and smoldering in the pellet hopper. It also holds the overpressure generated during the combustion process and prevents entry of flue gasses into pellet hopper.

## Boiler Control System

Boiler control system operates the heating boiler according to control system settings and also provides boiler monitoring and control via internet (additional option). Depending on the heat losses of a building, boiler control system automatically modulates and adjusts its power within a range of 30-100% from nominal output.

## Sensors and Thermostats

1. Protection against overheating of the boiler is provided by two thermostats – working thermostat and emergency thermostat. Working thermostat regulates boiler operation but emergency thermostat stops boiler operation in case of overheating;
2. Oxygen sensor (lambda probe) measures the amount of oxygen in flue gasses, and boiler control system correspondingly regulates the combustion process, constantly maintaining the most optimal combustion parameters;
3. Pellet level sensor stops boiler operation when pellets reach a low level, thus protecting the boiler and heating system from unnecessary cooling.

## Safety Guidelines

GRANDEG Turbo pellet heating boiler is specially designed thinking about user/operator safety. However, GRANDEG reminds that certain safety guidelines still must be observed during operation of any heating boiler. Safety guidelines set out below will help avoid hazardous situations and ensure a long operational life for your pellet heating boiler.

Designations:



**For your information**



**Mandatory requirement or limitation**

### **a. General Safety Information**



Please read the entire Operation and Installation Manual before using your pellet heating boiler and pay special attention to the Safety Guidelines. GRANDEG recommends observing those guidelines to avoid boiler misuse, potential damage or user/operator injuries.



Pellet heating boiler must be installed only by a competent certified service specialist. You will lose your warranty if it your boiler is not installed according to manufacturers' recommendations and local building and construction standards.



Pellet heating boiler and its related equipment must be installed and operated by adults only. Safety considerations pointed out here as well as in other parts of this Operation and Installation Manual should be carefully explained to elderly people, people with disabilities, and children. In addition, please note that limited access to the boiler during its operation may be required.



Parts of boiler surface may become hot during boiler operation. It is advisable to wear appropriate protective clothing, e.g. heat resistant gloves etc.



## **b. Safety Information for Moving and Transporting the Pellet Heating Boiler**



Be cautious when moving or lifting the pellet heating boiler or pellet hopper – these objects are heavy and may cause injury. Use appropriate lifting techniques and equipment. Make sure that exterior of the boiler is not damaged while lifting. When transporting the boiler, please check that a vehicle of appropriate size is used and safe fastening techniques are applied.

## **c. Safety Information for Installation of the Pellet Heating Boiler**



Pellet heating boiler connection to electrical current, existing heating system, water system, or flue pipes must be performed only by certified service specialist.



It is forbidden to connect the pellet heating boiler to electricity if all electrical nodes in the boiler have not been connected, or if the boiler has not been filled with heat carrier (water).



Do not connect boilers' flue pipe to the chimney which is already being used for another heating system. It is forbidden to mount chimneys' flue pipe directly on boilers' flue pipe. It is necessary to provide natural draft in the chimney in order to avoid possible risk of concentration of highly flammable flue.



Pellet heating boiler must be grounded according to local fire safety requirements.



After your boiler is installed, it is necessary to check and clean the solid particles filter of the boiler recirculation loop on a weekly basis, until no sediments are visible. Afterwards, cleaning is required only once a year.



It is recommended to install the pellet heating boiler in a room which is easily accessible in case of fire. In addition, it must be equipped with air supply, electrical current, and flue exhaust system.



It is forbidden to install the boiler in a room with a high level of dust and humidity.

# ***OPERATION AND INSTALLATION MANUAL***



It is forbidden to install a valve between the boiler and safety valve as well as between the boiler and expansion vessel.



Before planning any changes to heating boiler equipment or the layout of the boiler house, it is recommended to consult a certified service specialist about compliance of planned changes.

## **d. Safety Information for Operating the Pellet Heating Boiler**



Make sure that no external objects can get into pellet hopper. Do not refill the pellet hopper while the boiler is running. Do not use any other fuel instead of pellets.



Do not store pellets or other flammable materials near a running pellet heating boiler.



Do not cover ventilation hatches in the room where pellet heating boiler is located. Ventilation is necessary for safe and efficient boiler operation.



Do not run the boiler while burning chamber doors or ash compartment cleaning doors are open.



Never run the boiler if heating system pipes may be frozen.



If the pellet heating boiler is installed correctly, no smoke should get into premises. Sometimes smoke may be present if burning chamber doors are open while the boiler is running. However, if smoke is visible on regular basis, stop the boiler, open windows and doors to ventilate the room. Check if flue pipes require cleaning. Do not try to run the boiler while cause of smoke is not found and the problem is not resolved. If required, please contact certified service specialist for help.



Do not clean the inside of the boiler with water. Water can get into electrical or mechanical parts of the boiler causing damage.



Never use gasoline, petroleum or any other burning liquid to start or re-start the burning process in pellet heating boiler. Do not store all easily flammable liquids, including aerosols in the room where the boiler is located.



It is forbidden to operate the boiler in case of damaged boiler body, pellet burner, pellet supply mechanism, boiler control panel, or damages in the heating system. Also, it is forbidden to operate the boiler if there is no presence of natural draft in the chimney which may result in formation of highly flammable flue gasses in the burning chamber.



It is forbidden to rapidly open and close the shut-off valve between the boiler and the heating system.



In case of long intervals in between boiler operations during which air temperature in boiler house may drop below 0 °C, the heating system should be provided with alternative heat source.

### **e. Safety Information for Cleaning, Maintenance, and Repairs of the Pellet Heating Boiler**



Always allow the boiler to cool completely before opening ash compartment cleaning doors and starting to clean.



Always place ash in metal container (i.e., ash pan) to avoid fire outburst.



Lower quality pellets will require more frequent boiler cleaning and maintenance.



If you change your pellet supplier, GRANDEG recommends that you contact your installer to check, if adjustment of burner operation settings in the boiler control system is necessary.



Do not use plastic cleaning tools to clean the boiler. It is recommended to use only the set of cleaning tools included in the boiler equipment, or its equivalent. Always use heat resistant gloves and, if necessary, other protective clothing while cleaning the boiler.



After cleaning always make sure that burning chamber doors are completely closed before resuming boiler operation.

## **OPERATION AND INSTALLATION MANUAL**



It is recommended to perform cleaning of burning chamber, flue pipes, chimney, pellet supply mechanism and other mechanical parts of the boiler after the end of each heating season.



After your boiler is installed, it is necessary to check and clean the solid particles filter of the boiler recirculation loop on a weekly basis, until no sediments are visible. Afterwards, cleaning is required only once a year.



Only a GRANDEG certified service specialist may open the boiler control box.



If boiler repairs are necessary, we recommend using only GRANDEG manufactured replacement parts or ones approved by a GRANDEG certified service specialist.



It is required to call out a GRANDEG certified service specialist for boiler maintenance once a year, preferably at the end of heating season. Cleaning of chimney should also be performed by a specialist before or after the heating season.













It is forbidden to do boiler repair works (including welding), if the boiler is not stopped and cut off from electricity. It is also forbidden to remove and damage the ceramic isolation plates located in the doors of the boiler. The heat carrier (water) must not be emptied from the boiler and heating system, unless repair works are performed.

### **Signage on the Boiler**



For safe and convenient boiler operation, different informative and warning signs (for explanations, please refer to the table below) are placed on decorative siding of the boiler as well as on its equipment. These signs provide valuable safety information for the user/operator and ensure convenient and safe operation of the boiler.

<b>Informative Signs</b>	
	Max. temperature allowance for the heat carrier (water) in the boiler



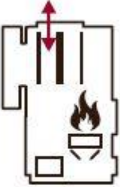

## OPERATION AND INSTALLATION MANUAL

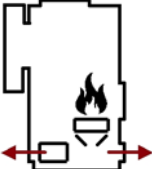
	<p>Max. pressure allowance for the heat carrier (water) in the boiler</p>
	<p>Electromechanical (stopping electricity supply) thermoprotection switch for protection against overheating of the heat carrier (water)</p>
	<p>Valve for regulating air overpressure in the pellet supply mechanism</p>
	<p>Valve for regulating combustion air supply</p>
	<p>Oxygen analyzer during combustion process (lambda probe)</p>
	<p>Max. operating temperature for heated heat carrier (water)</p>
	<p>Min. operating temperature for cooled heat carrier (water)</p>
	<p>Emergency stop button</p>
	<p>Location of heating boiler grounding</p>
	<p>Cleaning regularity of the heating boiler (times per month)</p>





## OPERATION AND INSTALLATION MANUAL

	Location of doors for cleaning heat exchanger tubes
	Location of hatch for cleaning boiler flue pipe
	Location of ash removal compartment

### Warning Signs

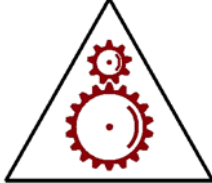
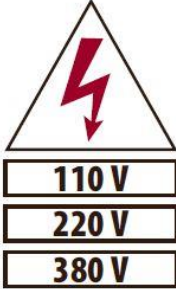
	All doors must be closed during operation of the heating boiler
	Warning! A corrosion protection system must be installed to ensure the min. required temperature for heat carrier (water) outflow from the heating system
	<b>Warning!</b> Hot surface!
	<b>Warning!</b> Rotating mechanism!

## OPERATION AND INSTALLATION MANUAL

	<p><b>Warning!</b> Moving mechanisms!</p>
	<p><b>Warning!</b> Electric power!</p>
	<p><b>Warning!</b> Use protective gloves when cleaning the heating boiler</p>
	<p>Rotation direction of the rotary airlock and pellet dosating valve</p>
	<p>Ignition element</p>

## **Fuel Recommendations**

Wood pellets must be dry, solid, mechanically durable, crumble-proof and free from chemical additives and foreign matter.

GRANDEG recommends purchasing pellets from producers that provide good pellet quality on a constant basis. Good quality fuel may cost more, but in return will result in substantially higher energy efficiency. Poor quality fuel will reduce heating boiler output and speed up boiler wear and tear. Thus, GRANDEG, recommends to pay due attention to the quality of pellets! Please note that boiler repairs due to using poor quality pellets are not covered by warranty.

GRANDEG recommends using pellets that meet the following production requirements:

<b>Technical parameter</b>	<b>Requirement</b>
Dimensions	6, 8 or 10 mm in diameter and 3-4 diameters in length)
Bulk density (Weight per volume)	650 – 750 kg per cubic metre
Heat capacity	4100 - 4300 KKal/kg
Ash and sand content	0,5% - 1,5% per pellet volume burned
Moisture content	8 – 10%



Pellets must be stored in a dry, well ventilated room to avoid contact with direct moisture (condensate or water). Burning moist pellets results in unnecessary consumption of heat energy for their drying, thus heating of the building will be less efficient. When affected by direct moisture, pellets may turn back into sawdust and disturb the operation of the boiler pellet supply mechanism. Please



## ***OPERATION AND INSTALLATION MANUAL***

note that storage time of pellets in polyethylene packaging is unlimited. Without protective packaging, pellets may be stored for several months since air humidity has a small effect on them.

To ensure optimal and efficient operation of your pellet heating boiler, GRANDEG recommends pellets that meet the following standards:

<b>European Union</b>	CEN TS 14961
<b>Austria</b>	ONORM M7135
<b>Germany</b>	DIN 51731
<b>Switzerland</b>	SN 166000
<b>Sweden</b>	SS 187120
<b>Great Britain</b>	The British BioGen Code of Practice for Biofuel
<b>USA</b>	Standard Regulations & Standards for Pellets in the US: The PFI



If you change your pellet supplier, GRANDEG recommends that you contact your installer to check, if adjustment of burner operation settings in the boiler control system is necessary.

## **User Information**

This section covers the following topics – commissioning of the heating boiler, its operation process and control system as well as maintenance and cleaning.

### **Commissioning**

In order to maintain your warranty, a GRANDEG certified service specialist should launch and commission your heating boiler.

#### **During Commissioning, your certified service specialist should:**

- Check if heating boiler (including equipment) is ready for operation
- Check if heating boiler is appropriately (in compliance with existing building laws) connected to the heating system and electrical power network
- Fill up the heating boiler and heating system with heat carrier (water) until the specified operating water pressure, and bleed the heating boiler afterwards. Check all connections and seals.
- Check if heating system and flue pipes are ready for work
- Turn on the circulation and recirculation pumps and check if operating water pressure does not exceed the allowance
- Check that all doors (burning chamber, ash compartment, heat exchanger) are compactly sealed and tightened. If necessary, change seals or adjust the door hinges so that the seals are evenly pressed to the door frame.
- Check and if necessary empty the condensate collector. Condensate may form during commissioning and operation of heating boiler. (Please refer to section **Recommendations for Flue Pipe Construction**).
- Set appropriate boiler operation parameters by using 'Login' button on the boiler control system control panel Information screen (Please refer to **Information screen description in the section Control System**).



It is forbidden to operate the boiler in case of damaged boiler body, pellet burner, pellet supply mechanism, boiler control panel, or damages in the heating system. Also, it is forbidden to operate the boiler if there is no presence of natural draft in the chimney which may result in formation of highly flammable flue gasses in the burning chamber.

When starting up your heating boiler on an everyday basis, we kindly ask you check the following:

- If the operating water pressure level is between 2-3 BAR,
- If all doors and hatches are sealed tightly,

# **OPERATION AND INSTALLATION MANUAL**

- If chimney condensate collector needs to be emptied,
- If pellet supply is sufficient
  
- If no alarms are present on Control Panel.

GRANDEG recommends contacting a certified service specialist in case you consider changing fuel (different biomass pellets), if pellet quality is better/worse than before, or adjustment of boiler output is necessary at the end of heating season.

## **Boiler Operation Process**

GRANDEG pellet heating boiler can be started by pressing 'Start' button on the Main screen of the Control panel (Please refer to the **Main Screen Description**). Overall, the boiler work cycle can be divided into twelve stages.

### **12 stages of the boiler work cycle**

#### **Pre-Load**

1. Water recirculation pump is started
2. Ignition element is cleaned with air flow for 60 seconds
3. After cleaning, initial load of pellets is supplied to burning chamber for 3 minutes.

Sequence steps indicated on Main screen in Control panel that correspond to current stage of work cycle:

<b>Step No.</b>	<b>Step description in Info screen</b>	<b>Full description</b>
Step 20	Ignition. Blow out heaters, Load initial amount of fuel	Ignition element is cleaned; Initial load of pellets is supplied

#### **Ignition**

1. Ignition element is started

# **OPERATION AND INSTALLATION MANUAL**

2. After 30 seconds air fan vault is opened and air fan is started at low load, waits 13 minutes until next step
3. Flame presence is determined by lambda probe (oxygen level in flue gases should be less than 80% for at least 5 seconds)

Sequence steps indicated on Main screen in Control panel that correspond to current stage of work cycle:

<b>Step No.</b>	<b>Step description in Info screen</b>	<b>Full description</b>
Step 21	Ignition. Check ignition attempt count less than max	Starting ignition element; Max 3 starting attempts
Step 22	Ignition. Run heaters only	First 30 seconds after ignition element is started (without air fan)
Step 23	Ignition. Run heaters and fans	Ignition element and air fan running

## **Stabilization**

1. Ignition element is switched off
2. Air fan power is increased to supply more air to burning chamber, waits 13 minutes until next step
3. Flame presence is determined by lambda probe (oxygen level in flue gases should be less than 80% for at least 5 seconds)

Sequence steps indicated on Main screen in Control panel that correspond to current stage of work cycle:

<b>Step No.</b>	<b>Step description in Info screen</b>	<b>Full description</b>
Step 24	Ignition. Heaters OFF. Fan(s) ON	Ignition element is switched off, air fan power is increased.

## **Burning chamber heating**

1. Air fan power is increased.
2. Screw feeder supplies pellets into burning chamber at minimal load
3. Flame presence is determined by lambda probe (oxygen level in flue gases should be less than 80% for at least 5 seconds)
4. After 13 minutes if flame presence is confirmed, boiler switches to Run mode. If flame is not present, boiler returns to Ignition and reignites.

# OPERATION AND INSTALLATION MANUAL



If 3 reigniting attempts are not successful, boiler remains at Ignition stage, generates an alarm and waits for operator command. By pressing Reset button on Alarm screen, operator confirms that boiler should go to next three attempts to reignite. If unsuccessful, press Stop button and call support.

Sequence steps indicated on Main screen in Control panel that correspond to current stage of work cycle:

Step No.	Step description in Info screen	Full description
Step 25	Ignition. Heat up boiler. Fans ON. Motor OFF	Air fan power is increased (right before screw feeder is turned on)
Step 26	Ignition. Heat up boiler. Fans ON. Motor ON	Air fan is running, screw feeder starts regular supply of pellets

## Run

1. Pellets are supplied into burning chamber. Fuel load depends on calculated boiler load which is determined automatically based on the boiler temperature or can be manually set by service person during boiler commissioning (at 30%, 60% or 100%).
2. Depending on the oxygen level in flue gases (determined by lambda), boiler controls regulate air fan power and resulting air amount in burning chamber.
3. If temperature inside boiler reaches high set point (waiting set point), boiler switches to waiting mode.
4. If the screw feeder motor work hours (can be seen on Main screen) have reached cleaning level, boiler automatically goes to cleaning mode. After cleaning, boiler will restart automatically.

Sequence steps indicated on Main screen in Control panel that correspond to current stage of work cycle:

Step No.	Step description in Info screen	Full description
Step 28	Work cycle. Run on 30% load.	Boiler running on set 30% load
Step 29	Work cycle. Run on 60% load.	Boiler running on set 60% load.

## **OPERATION AND INSTALLATION MANUAL**

Step 30	Work cycle. Run on 100% load.	Boiler running on set 100% load.
Step 31	Work cycle. Variable load according PID controller.	Boiler running on variable load, determined automatically

### **Waiting**

1. Air fan is off, air vault is closed, and screw feeder is off. Boiler waits for temperature decrease.
2. When boiler temperature falls until set point, boiler switches to Run mode.

Sequence steps indicated on Main screen in Control panel that correspond to current stage of work cycle:

<b>Step No.</b>	<b>Step description in Info screen</b>	<b>Full description</b>
Step 27	Work cycle. Pause or temperature in boiler high	Boiler is in standby mode after pressing Pause button or when temperature inside boiler is too high

### **Burn out (extinguishing)**

1. Air fan is switched on, air vault is opened, and screw feeder has stopped supplying pellets to the burner.
2. If boiler temperature is higher than high set point, air fan is stopped and vault closed, until temperature falls to set point. After temperature has reached required limit, burn out process continues.
3. After air fan has uninterruptedly worked for 10 minutes, boiler switches to cleaning stage, air fan is switched off, vault closed.

Sequence steps indicated on Main screen in Control panel that correspond to current stage of work cycle:

<b>Step No.</b>	<b>Step description in Info screen</b>	<b>Full description</b>
Step 1	Check for previous condition	Check for previous condition of the boiler to determine next sequence step
Step 2	Burn out pellets	Screw feeder has stopped supplying pellets, while boiler continues running until temperature falls
Step 3	After burn out delay	10 minutes of air fan working and vault opened to burn out remaining pellets

## Cleaning 1

1. Both right and left cleaning bolts are opened.
2. If in 200 seconds open limit switch signals, confirming opening of the bolts, do not appear, control system tries to close and then reopen bolts.



If three attempts are unsuccessful, alarm is indicated and boiler waits for operator command.

3. Boiler switches to Cleaning 2 after both limit switch signals confirming opening of the bolts appear.

Sequence steps indicated on Main screen in Control panel that correspond to current stage of work cycle:

Step No.	Step description in Info screen	Full description
Step 4	Clean Left and Right counters	Confirmation to start cleaning process
Step 5	Cleaning. Check Left and Right open attempt count < Max	System checks if attempts to open cleaning bolts have not exceeded maximum allowance (3 attempts)
Step 6	Cleaning. Open Left and Right cleaning	Left and right cleaning bolts are being opened
Step 7	Cleaning. Open fail, try to close	System registers failed attempt to open cleaning bolts and tries to close and reopen again
Step 8	Empty	Empty
Step 9	Empty.	Empty
Step 10	Empty.	Empty

## Cleaning 2

1. Right cleaning bolt is closed.
2. If closed limit switch does not appear in 200 seconds, system tries to open and then reclose.



If three attempts are unsuccessful, alarm is indicated and boiler waits for operator command.

## **OPERATION AND INSTALLATION MANUAL**

3. Boiler switches to Cleaning 3 after limit switch signal appears.

Sequence steps indicated on Main screen in Control panel that correspond to current stage of work cycle:

<b>Step No.</b>	<b>Step description in Info screen</b>	<b>Full description</b>
Step 11	Cleaning. Left and Right opened stay time	200 second time limit for cleaning stage
Step 12	Cleaning. Check Right close attempt count less max	System checks if attempts to close right cleaning bolt have not exceeded maximum allowance (3 attempts)
Step 13	Cleaning. Close Right cleaning	Right cleaning bolt is being closed
Step 14	Cleaning. Right cleaning closing failed - reopen.	System registers failed attempt to close right cleaning bolt and tries to open and reclose again

### **Cleaning 3**

1. Left cleaning bolt is closed.
2. If closed limit switch does not appear in 200 seconds, system tries to open and then reclose.



If three attempts are unsuccessful, alarm is indicated and boiler waits for operator command.

3. After both limit switch signals appear, boiler resets screw feeder work time counter (can be seen on Main screen) and switches to Stop (if the Stop command was given) or returns to Pre-load, if cleaning was carried out automatically.

Sequence steps indicated on Main screen in Control panel that correspond to current stage of work cycle:

<b>Step No.</b>	<b>Step description in Info screen</b>	<b>Full description</b>
Step 15	Cleaning. Check Left close attempt count less max	System checks if attempts to close left cleaning bolt have not exceeded maximum allowance (3 attempts)
Step 16	Cleaning. Close left cleaning.	Left cleaning bolt is being closed
Step 17	Cleaning. Left cleaning closing failed - reopen	System registers failed attempt to close left cleaning bolt and tries to open and reclose again



## **OPERATION AND INSTALLATION MANUAL**

Step 18	Empty.	Empty
Step 19	Cleaning. Reset work hours counter	Boiler resets screw feeder work time counter to zero

### **Stop**

1. Recirculation pump works for 15 minutes and stops.
2. Boiler is stopped and ready for Start.

Sequence steps indicated on Main screen in Control panel that correspond to current stage of work cycle:

<b>Step No.</b>	<b>Step description in Info screen</b>	<b>Full description</b>
Step 0	Preparation for start. For start: Cleaning closed, Air fans stopped, motor stopped, pellet present	Boiler is stopped and ready for start. Cleaning bolts are closed, air fans are idle, screw feeder is idle, pellets are present

### **Pause**

1. Can be activated at any stage by pressing Pause button on Main screen.
2. Screw feeder, air fan is off, vault is closed, and recirculation pump works.
3. Previous stage is resumed by pressing Resume button on Main screen

Sequence steps indicated on Main screen in Control panel that correspond to current stage of work cycle:

<b>Step No.</b>	<b>Step description in Info screen</b>	<b>Full description</b>
Step 27	Work cycle. Pause or temperature in boiler high	Boiler is in standby mode after pressing Pause button or when temperature inside boiler is too high



It is forbidden to do boiler repair works (including welding), if the boiler is not stopped and cut off from electricity. It is also forbidden to remove and damage the ceramic isolation plates located in the doors of the boiler. The heat carrier (water) must not be emptied from the boiler and heating system, unless repair works are performed.



In case of long intervals in between boiler operations during which air temperature in boiler house may drop below 0 °C, the heating system should be provided with alternative heat source.



Before planning any changes to heating boiler equipment or the layout of the boiler house, it is recommended to consult a certified service specialist about compliance of planned changes.

## Control System

Boiler control system controls the operation of the boiler and consists of a programmable logic controller (PLC) and control panel. Boiler Control system regulates and monitors combustion process to ensure efficient, safe and low-emission boiler operation.

The following sensors supply boiler control system with the required information:

- Flue gas temperature probe – measures temperature of the flue gases
- Flue gas oxygen level probe (lambda) – measures oxygen level in the flue gases
- Thermostat – measures the temperature of the water in the boiler
- Pellet level sensor – signals to the boiler control system that the pellets in the hopper have reached a low level
- Emergency thermostat – gives a signal to control system, that water temperature has reached an unsafe limit (above 95 °C)

Boiler control system is controlled by the PLC and Operator/User of the heating boiler. When boiler control system is working under normal circumstances (emergency situation is not established), heating boiler is working independently according to the boiler operation settings and does not require any intervention from the Operator/User. Once an emergency situation or its' precondition is established (Please refer to section Potential alarms and solutions), boiler control system evaluates the potential danger and informs Operator/User of required action under given circumstances.

The Operator/User can manage the boiler control system and change its settings via control panel. Its' main screen displays current technical data of the boiler and allows to make changes to boiler work modes. From the Main Screen Operator/User can navigate to Information screen with displays current work cycle step of the boiler (please refer to section Boiler Operation Process) and allows to further navigate to alarms, history and other screens (Please refer to descriptions of control panel screens below).

# **OPERATION AND INSTALLATION MANUAL**

## **Main Screen Description**

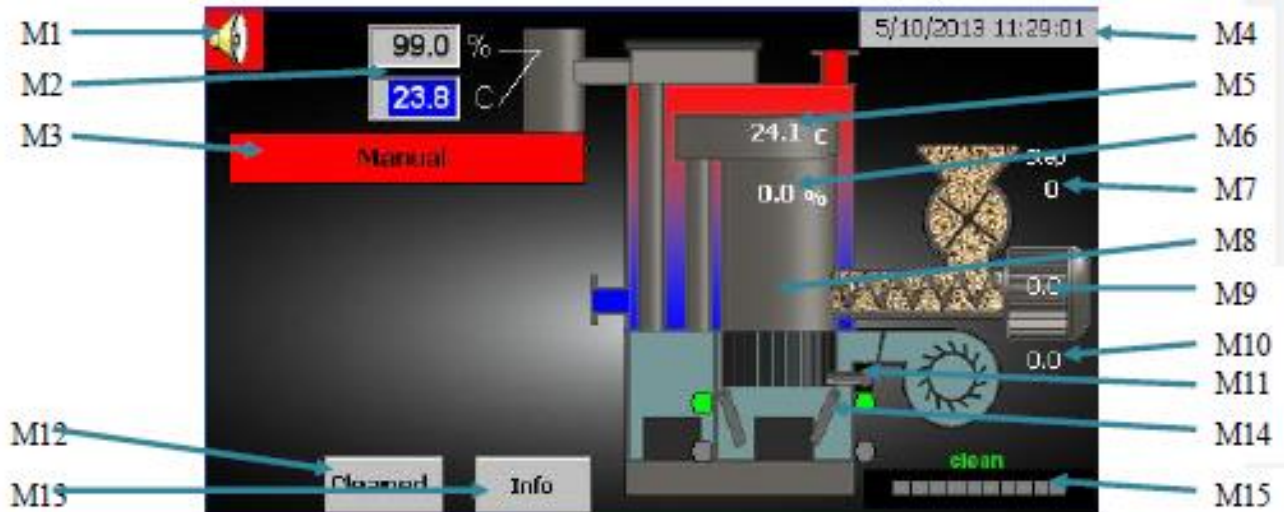

No	Description/Function
M1	Alarm button (Blinks at presence of emergency situations in the system. When pressed, opens Alarm screen (please refer to <b>Alarm screen description</b> ))
M2	Flue gas temperature and lambda probe
M3	Text window with current boiler system information (please refer to the <b>Table below for all options</b> )
M4	Current date and time
M5	Boiler temperature
M6	Calculated boiler load (%)
M7	Sequence step (please refer to step descriptions in <b>Boiler work process section</b> )
M8	Burning chamber status: <ul style="list-style-type: none"> <li>• Empty – boiler is cleaned</li> <li>• Pellets without flame, blinking – boiler is loaded with pellets</li> <li>• Pellets with flame, blinking – ignition or burnout stage</li> <li>• Pellets and flame – Working stage</li> </ul>
M9	Screw feeder load (%)
M10	Air fan load (%)
M11	Air fan vault. The following options are possible: If represented across air duct – 'off' state If represented along air duct – 'on' state
M12	Boiler control button. The following options are possible: <ul style="list-style-type: none"> <li>• START (starts boiler operation)</li> </ul>

## **OPERATION AND INSTALLATION MANUAL**

	<ul style="list-style-type: none"> <li>• STOP (stops boiler operation)</li> <li>• PAUSE (stops boiler operation)</li> <li>• RESUME (starts boiler operation after pause)</li> <li>• CLEANED (confirms completion of manual cleaning)</li> </ul>
M13	Info button (switches Main screen to Info screen, please refer to <b>Info screen description</b> )
M14	Boiler automatic cleaning bolts and limit switches. The following options are possible: <ul style="list-style-type: none"> <li>• Grey - Not active, bolt is not on limit switch</li> <li>• Green, blinks - Bolt has a command to reach this limit switch, but not yet reached</li> <li>• Green - Active, bolt is on the limit switch</li> <li>• Red - Bolt or limit switch fault</li> </ul>
M15	Work time counter (since last cleaning). When maximum reached, boiler switches to automatic cleaning or requests manual cleaning

**The following boiler control system information can be displayed in the text window M3:**

<b>System information displayed in text window M3</b>	<b>Explanation</b>
Manual	Boiler in manual control mode
Not ready	Boiler in auto mode and not ready to work
Ready	Boiler in auto mode and ready to work
Ignition	Boiler in auto mode and igniting
Working	Boiler in auto mode and running
Working - Waiting	Boiler is in auto mode and waiting for temperature decrease
Burn out	Boiler in auto mode and extinguishing (remaining pellets are used without supplying new ones)
Cleaning	Boiler in auto mode and cleaning (automatic or manual)
Pause	Boiler is in auto mode and paused automatically in case of pellet absence (after adding pellets, boiler will re-start automatically)
Remote – Manual	Boiler is controlled remotely (other controller) and in manual mode
Remote – Not ready	Boiler is controlled remotely (other controller), in auto mode, and not ready to work
Remote - Ready	Boiler is controlled remotely (other controller), in auto mode, and ready to work
Remote - Ignition	Boiler is controlled remotely (other controller), in auto mode, and igniting

## **OPERATION AND INSTALLATION MANUAL**

Remote - Working	Boiler is controlled remotely (other controller), in auto mode, and running
Remote - Burn out	Boiler is controlled remotely (other controller), in auto mode, and extinguishing (remaining pellets are used without supplying new ones)
Remote -Cleaning	Boiler is controlled remotely (other controller), in auto mode, and cleaning (automatic or manual)
Remote - Pause	Boiler is controlled remotely (other controller), in auto mode, and paused automatically (in case of pellet absence, after adding pellets boiler will re-start automatically) or by operator (in this case boiler will start only after operator command)
Stopping - Burn out	Boiler is in auto mode, stopped manually by operator, and extinguishing (remaining pellets are used without supplying new ones)
Stopping - Cleaning	Boiler is in auto mode, stopped manually by operator, and cleaning (automatic or manual)
Stopping - Pause	Boiler is in auto mode, stopped manually by operator (stopping process will be resumed only after operator command)

### **Info Screen Description**

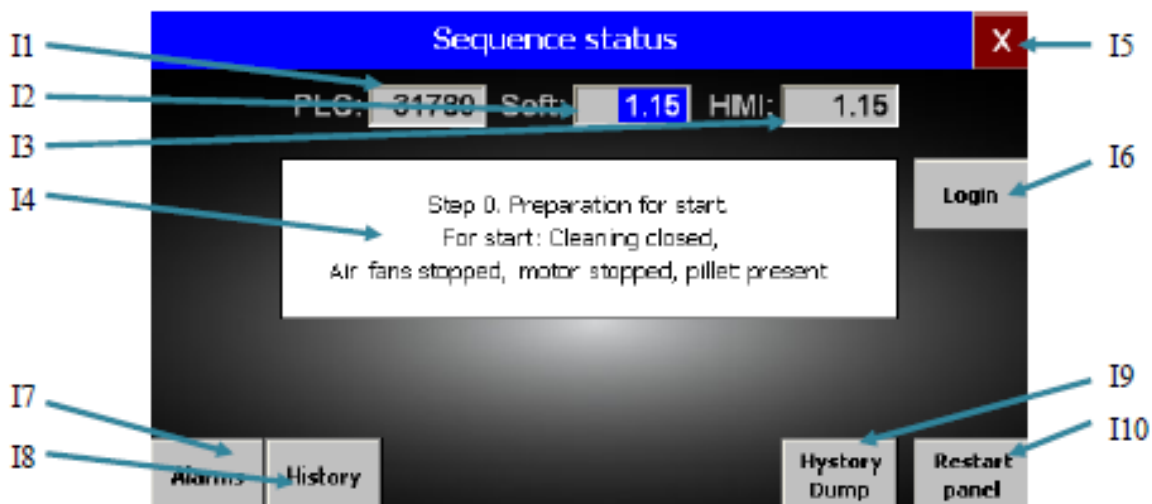

No	Description/Function
I1	PLC (Programmable Logic Controller) type
I2	Controller software version
I3	Control panel software version
I4	Sequence information text window (please refer to descriptions in <b>Boiler work process section</b> )

## **OPERATION AND INSTALLATION MANUAL**

I5	Exit Info screen
I6	User Login/Logout (used only by service personnel)
I7	Go to Alarm History (please refer to <b>Alarm history screen description</b> )
I8	Go to Historical Data Screen (please refer to <b>Historical data screen description</b> )
I9	Export all historical data to flash card
I10	Restart button restarts the control panel

### **Alarms Screen Description**



<b>No</b>	<b>Description/Function</b>
A1	List of current emergency and warning alarms. Alarm number, time and date of alarm occurrence, alarm acknowledgement status and explanation text are displayed (please refer to <b>Potential alarms and solutions list</b> )
A2	Exit Alarms screen
A3	Acknowledge all alarms displayed on the Alarms screen. By pressing this button operator confirms that he has read and understood all alarms displayed on the Alarms screen.
A4	Resets current alarm signals that have been resolved. Button must be pressed to restart boiler operation after emergency stop.
A5	Go to Alarms history screen (please refer to <b>Alarm history screen description</b> )

# **OPERATION AND INSTALLATION MANUAL**

## **Potential Alarms and Solutions List**

<b>Alarm text</b>	<b>Cause</b>	<b>Operator response</b>
Emergency stop (Button or overheat)	Emergency button is pressed	Release emergency stop button
	Boiler has overheated	Check boiler temperature. After temperature has fallen to normal, release temperature safety switch
Unable to open/close left cleaning	Mechanical obstacle, that does not allow bolt to open or close	Check mechanical bolt inside burning chamber. Remove obstacles. Press Reset button on Alarms screen
	Bolt is damaged	Call support
	Limit switch is damaged	Call support
Unable to open/close Right cleaning	Mechanical obstacle, that does not allow bolt to open or close	Check mechanical bolt inside burning chamber. Remove obstacles. Press Reset button on Alarms screen
	Bolt is damaged	Call support
	Limit switch is damaged	Call support
Motor-reducer - Communication lost	-	Check if emergency button is not pressed and boiler not overheated. Press Reset button on Alarms screen, if unsuccessful -call support
Motor-reducer - Fault (see code)	-	Check if emergency button is not pressed and boiler not overheated. Press Reset button on Alarms screen, if unsuccessful -call support
Air fans power supply fault	Protection circuit breaker is switched off.	Call support
Left cleaning not closed	Boiler is not ready to start, as left cleaning bolt is not closed	Wait for 5 minutes. If alarm still present, check mechanical bolt inside burning chamber. Remove obstacles. Press Reset button on Alarms screen

## **OPERATION AND INSTALLATION MANUAL**

	Bolt is damaged	Call support
	Limit switch is damaged	Call support
Right cleaning not closed	Boiler is not ready to start, as right cleaning bolt is not closed	Wait for 5 minutes. If alarm still present, check mechanical bolt inside burning chamber. Remove obstacles. Press Reset button on Alarms screen
	Bolt is damaged	Call support
	Limit switch is damaged	Call support
Recirculation pump power supply fault	Protection circuit breaker is switched off.	Call support
PLC not initialized	-	Call support
Ignition fails	Ignition element is damaged	Call support
	Pellet level low in burning chamber	Call support
Pellets absent - Pause	Pellet level in storage low	Refill storage
	Sensor fault	Call support
Temperature too low - Stop	Temperature inside boiler is too low for long time (more than 2 h).	Reduce heat consumption from boiler
	Boiler is not ignited	Reignite boiler
Lambda sensor fault	Lambda sensor measurements are outside work area	Call support
Boiler temperature sensor fault	Boiler temperature sensor measurements are outside work area	Call support
Flue gas temperature sensor fault	Flue gas temperature sensor measurements are outside work area	Call support
Funnel bypass opened - Pause	Bypass opened	Close bypass
	Sensor fault	Call support
Pellets absent	Pellet level in storage low	Refill storage
Boiler temperature Low	Boiler inside temperature too low, if this condition continues for 2 h, boiler will stop.	Reduce heat consumption from boiler



## Alarms History Screen Description

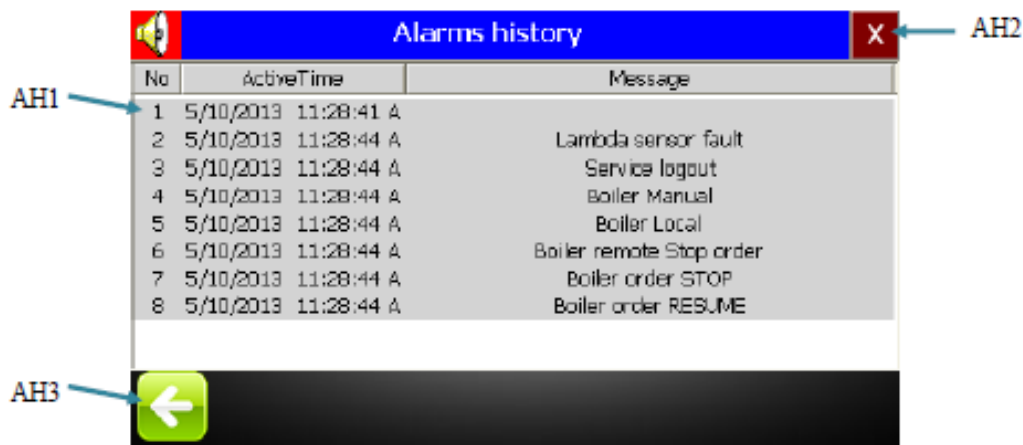

No	Description/Function
AH1	List of all historical emergency and warning alarms. Alarm number, time and date of alarm occurrence, alarm acknowledgement status and explanation text are displayed (please refer to <b>Potential alarms and solutions list</b> )
AH2	Exit Alarm history screen
AH3	Go to Alarms screen (please refer to <b>Alarms screen description</b> )

## Historical Data Screen Description

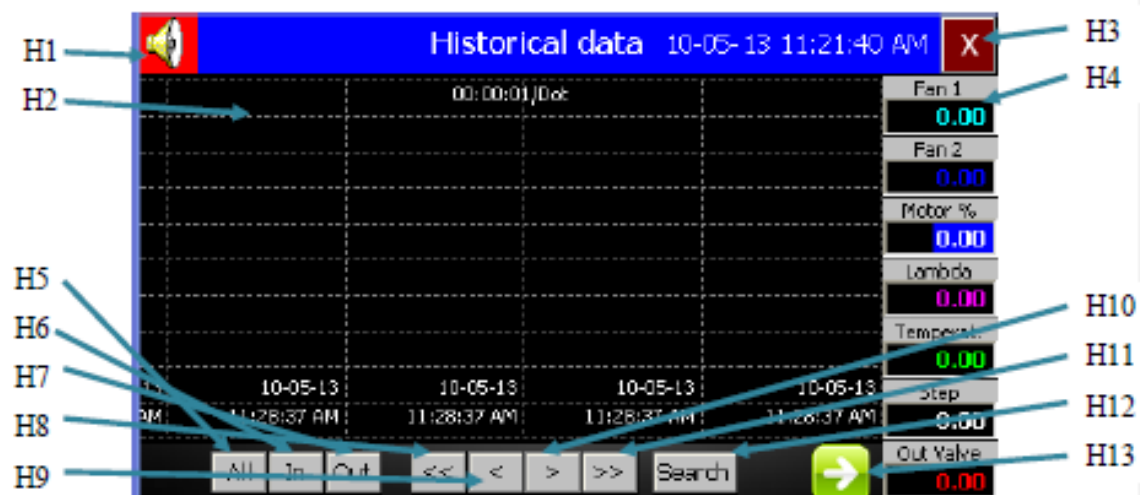

# **OPERATION AND INSTALLATION MANUAL**

<b>No</b>	<b>Description/Function</b>
H1	Go to Alarms screen
H2	Graphical representation of system parameters
H3	Exit History data screen
H4	Current parameter value
H5	View a graphical representation of all parameter values over the past 24 hours
H6	Browsing parameter data graph - Zoom in
H7	Browsing parameter data graph -Zoom out
H8	Browsing parameter data graph -Go to Beginning
H9	Browsing parameter data graph -Go Back
H10	Browsing parameter data graph -Go Forward
H11	Browsing parameter data graph -Go to End
H12	Browsing parameter data graph - Search by Date
H13	Go to Oxygen historical data screen (please refer to <b>Oxygen Historical Data Screen Description</b> )

## Oxygen Historical Data Screen Description

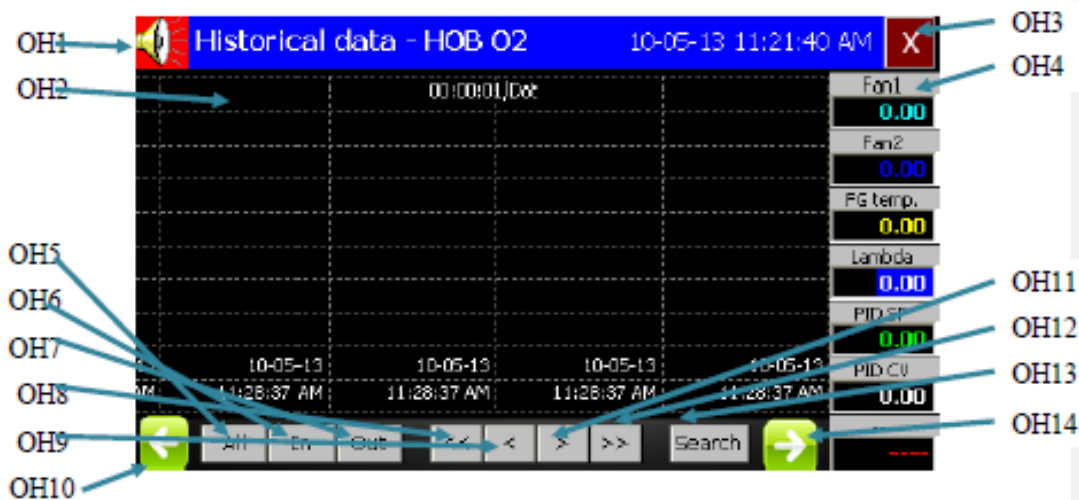

<b>No</b>	<b>Description/Function</b>
OH1	Go to Alarms screen
OH2	Graphical representation of system parameters
OH3	Exit History data screen
OH4	Air system data
OH5	View a graphical representation of all parameter values over the past 24 hours

## **OPERATION AND INSTALLATION MANUAL**

OH6	Browsing parameter data graph - Zoom in
OH7	Browsing parameter data graph -Zoom out
OH8	Browsing parameter data graph -Go to Beginning
OH9	Browsing parameter data graph -Go Back
OH10	Go to Historical data screen
OH11	Browsing parameter data graph -Go Forward
OH12	Browsing parameter data graph -Go to End
OH13	Browsing parameter data graph - Search by Date
OH14	Go to Boiler temperature historical data screen (please refer to <b>Boiler Temperature Historical Data Screen Description</b> )

### **Boiler Temperature Historical Data Screen Description**

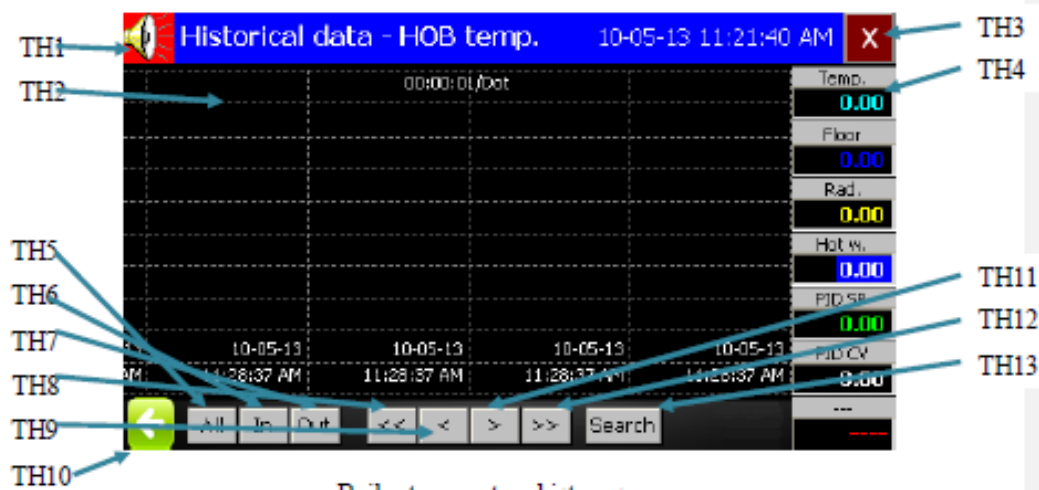

No	Description/Function
TH1	Go to Alarms screen
TH2	Graphical representation of system parameters
TH3	Exit History data screen
TH4	Data on system temperatures
TH5	View a graphical representation of all parameter values over the past 24 hours
TH6	Browsing parameter data graph - Zoom in
TH7	Browsing parameter data graph -Zoom out
TH8	Browsing parameter data graph -Go to Beginning
TH9	Browsing parameter data graph -Go Back
TH10	Go back to Oxygen historical data screen (please refer to <b>Oxygen historical data screen description</b> )
TH11	Browsing parameter data graph -Go Forward
TH12	Browsing parameter data graph -Go to End
TH13	Browsing parameter data graph - Search by Date

## Boiler Maintenance

Pellet heating boiler is equipped with self-cleaning pellet burner and self-cleaning heat exchanger. For boiler to run properly and most effectively, it is required to regularly check and, if necessary, manually clean the following parts of the pellet heating boiler:

<b>Recommended Frequency of Cleaning</b>	<b>Part of the Pellet Heating Boiler</b>
Once a month	Heat exchanger
Once a week	Ash compartment in the front and on both sides of the boiler
Once a week	Pellet burning zone (pellet burner and burning chamber)

Since the required boiler cleaning frequency depends on pellet quality as well as boiler operation intensity, we recommend monitoring the performance of your boiler very closely and, if necessary, cleaning it more frequently than indicated above.

For convenient boiler cleaning, a set of cleaning tools is included in your boiler set. It consists of the following:

- Ash pan
- Cleaning brush
- Ash removal shovel
- Slag removal stick

GRANDEG reminds you that you should take care not only of your pellet heating boiler technical and visual state, but also of the whole heating system, including flue pipes and chimneys. GRANDEG recommends performing cleaning of horizontal parts and bends in flue pipes once a month.



Lower quality pellets will require more frequent boiler cleaning and maintenance.

### **In order to perform manual boiler cleaning:**

- Press button „**STOP**“ on control panel main screen;
- Wait for the boiler to stop running
- Put on heat resistant gloves and prepare metal container for ash

- Open ash compartment cleaning front doors and with the help of metal brush and ash pan remove ash that has accumulated under the pellet burner (burning chamber). Close ash compartment cleaning front doors.
- Open both ash compartment cleaning doors on both sides and with the help of metal brush and ash pan remove ash that has accumulated under the pellet burner (burning chamber). Close ash compartment cleaning doors on both sides.
- Open heat exchanger cleaning doors and with the help of metal brush clean all heat exchange tubes along their entire length. Close heat exchanger cleaning doors.
- Open burning chamber doors and visually assess the cleanliness of pellet burning zone. If necessary, clean ash from pellet burner. Close burning chamber doors.
- Press button „**CLEANED**“ on control panel main screen to confirm completion of manual boiler maintenance cleaning;
- Press button „**START**“ on control panel main screen to resume boiler operation.



After your boiler is installed, it is necessary to check and clean the solid particles filter of the boiler recirculation loop on a weekly basis, until no sediments are visible. Afterwards, cleaning is required only once a year.

At the end of every heating season the pellet hopper and screw feeder needs to be cleaned completely. Otherwise, as a result of surrounding moisture, pellets that are left inside may expand and block the screw feeder at the beginning of next heating season.

## **Annual maintenance**

Annual maintenance is required at the end of every heating season. If annual maintenance is not performed, you will invalidate the warranty of your pellet heating boiler. Annual maintenance is a chargeable service performed by GRANDEG certified service specialist.

Before annual maintenance the user or operator of the pellet heating boiler is required to:

- Perform cleaning of the boiler and burner;
- Perform cleaning of horizontal and vertical flue pipes and chimney;
- Make sure that boiler and heating system is filled with heat carrier (water);
- Make sure that the boiler is connected to electrical current.

Responsibilities of service specialist performing annual maintenance are listed in Annex No. 1, „**Annual maintenance form**“.

## Installation Information

This section contains information on the installation requirements for your heating boiler, its dimensions and required clearance from nearby objects, technical data, recommended connection schemes and installation process and recommendations for flue pipe construction.

### Installation Requirements

Pellet heating boiler must be installed vertically on a smooth, flat, and fire-proof surface or a fire-proof base which exceeds size of the boiler by a minimum of 30 cm in the front and by 10 cm on other sides, according to construction and operation regulations. Surface under the boiler must hold the weight of the boiler filled with heat carrier (water), pellet hopper, as well as other connected equipment. Boiler room should be frost-resistant (temperature should not drop below +5°C) and well ventilated.

During boiler installation it is required to observe the corresponding connection sizes and recommended clearances around the boiler (Please refer to section **Boiler Dimensions and Recommended Clearances**). The following minimal clearances are required from the boiler to other objects/surfaces or flammable materials:

Degree of Flammability	Minimal Clearance
Low or medium (grade B, C1, C2)	200 mm
High (fuel, burning materials)	400 mm
Unknown/Can't be established	400 mm

Boiler house or room where boiler is located must comply with Heating and Ventilation Standards LBN 231-03, Fire Safety Standards LBN 201-96 or other corresponding local regulations.

Installation of the pellet heating boiler must be performed according to regulations "On boiler with steam pressure under 0.07 MPa (0.7 kg/cm<sup>2</sup>), boiler and water heater with water temperature below 388K (1150°C) safe structure and operation", as well as 12.06.2001. regulations No. 241 of The Cabinet of Ministers of the Republic of Latvia "Boiler technical monitoring procedure" and "Construction rules of electrical equipment", or other corresponding local regulations

# **OPERATION AND INSTALLATION MANUAL**

## Boiler Dimensions and Recommended Clearances

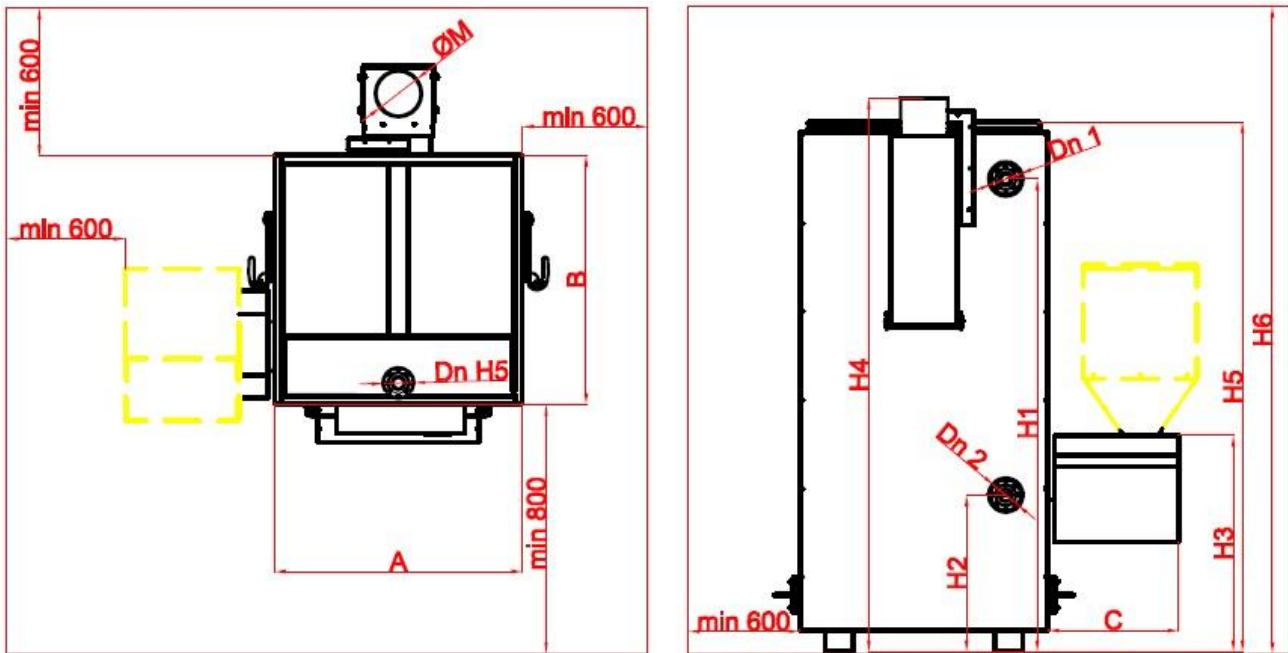

Boiler	A	B	C	ø M	Dn 1	Dn 2	Dn H5	H1	H2	H3	H4	H5	H6
<b>GD TURBO 70</b>	900	918	615	196	Ø60 (1/2")	Ø60 (1/2")	Ø60 (1/2)	1560	764	851	1884	1804	2750
<b>GD TURBO 100</b>	900	918	615	196	Ø60 (1/2")	Ø60 (1/2")	Ø60 (1/2)	1875	825	1615	2185	2104	3000
<b>GD TURBO 200</b>	1122	1195	640	305	DN50	DN65	DN65	1930	895	1760	2279	2240	3150
<b>GD TURBO 300</b>	1122	1195	640	305	DN50	DN65	DN65	2535	895	964	3004	2850	3300
<b>GD TURBO 500</b>	1517	1589	720	396	DN50	DN80	DN80	2950	1280	1117	3328	3290	3800

## Technical data

	<b>Turbo Series Pellet Heating Boilers</b>	<b>70 kW</b>	<b>100 kW</b>	<b>200 kW</b>	<b>300 kW</b>	<b>500 kW</b>
<b>1.1.</b>	Nominal power, kWh ( $\pm 10\%$ )	70	100	200	300	500
<b>1.2.</b>	Total efficiency factor, %	not less than 90	not less than 90	not less than 90	not less than 90	not less than 90
<b>1.3.</b>	Operating water pressure in the boiler, MPa (kg/cm <sup>2</sup> ) ( $\pm 0,2\%$ )	0.2 (2)	0.2 (2)	0.2 (2)	0.2 (2)	0.2 (2)
<b>1.4.</b>	Minimum water pressure in the boiler at a temperature of 90°C, MPa (kg/cm <sup>2</sup> )	0.05 (0.5)	0.05 (0.5)	0.1 (1)	0.1 (1)	0.1 (1)
<b>1.5.</b>	Maximum inflow water temperature, °C	90	90	90	90	90
<b>1.6.</b>	Minimum outflow water temperature, °C	70	70	70	70	70
<b>1.7.</b>	Operating temperature of the heating boiler, °C	70-90	70-90	70-90	70-90	70-90
<b>1.8.</b>	Minimum temperature of exhaust flue gases, °C	110	110	110	110	110
<b>1.9.</b>	Air consumption for burning of fuel material, m <sup>3</sup> /h	not more than 88	not more than 125	not more than 252	not more than 378	not more than 630
<b>1.10.</b>	Consumption of wood pellets at maximum capacity, kg/h	not more than 16	not more than 23	not more than 46	not more than 69	not more than 115
<b>1.11.</b>	Area of the heat exchanger surface, m <sup>2</sup>	3.5	7.4	14.9	22.7	37.6
<b>1.12.</b>	Volume of water in the boiler (litres) ( $\pm 0,2\%$ )	169	291	808	1206	2014
<b>1.13.</b>	Weight of the boiler (w/o the pellet hopper), kg	760	800	1150	1450	1885
<b>1.14.</b>	Electric power consumption, kWh	0.38	0.38	0.9	0.9	0.9
<b>1.15.</b>	Carbon dioxide CO content in combustion products by the boiler, mg/m <sup>3</sup> , not more than					
	• For wood pellets	550	550	550	550	550
	• For dry corn	650	650	650	650	650
	• For biomass pellets	650	650	650	650	650
<b>1.16.</b>	Content of nitrogen oxides NO <sub>2</sub> in combustion products by the boiler, mg/m <sup>3</sup> , not more than					
	• For wood pellets	120	120	120	120	120
	• For dry corn	130	130	130	130	130



## **OPERATION AND INSTALLATION MANUAL**

	• For biomass pellets	650	650	650	650	650
<b>1.17.</b>	Emissions (grams/h), for a properly set-up and cleaned boiler	0,045	0,064	0,129	0,193	0,322
<b>1.18.</b>	Level of noise generated by the boiler during its operation, dB, not more than	35	35	35	85	85
<b>1.19.</b>	Voltage, V (50 Hz)	220	220	380	380	380
<b>1.20.</b>	Calorific power of wood pellets, Kcal/kg	4100 – 4300	4100 – 4300	4100 – 4300	4100 – 4300	4100 – 4300
<b>1.21.</b>	Density of wood pellets, kg/m <sup>3</sup>	650 – 750	650 – 750	650 – 750	650 – 750	650 – 750
<b>1.22.</b>	Permissible humidity of wood pellets, %	8 – 10	8 – 10	8 – 10	8 – 10	8 – 10
<b>1.23.</b>	Permissible ash content within the fuel material, % of volume	0.25 – 0.75	0.25 – 0.75	0.25 – 0.75	0.25 – 0.75	0.25 – 0.75

Please note that the above data represent boiler performance at nominal output.

## Recommended Connection Schematics

### Water Connections Schematic

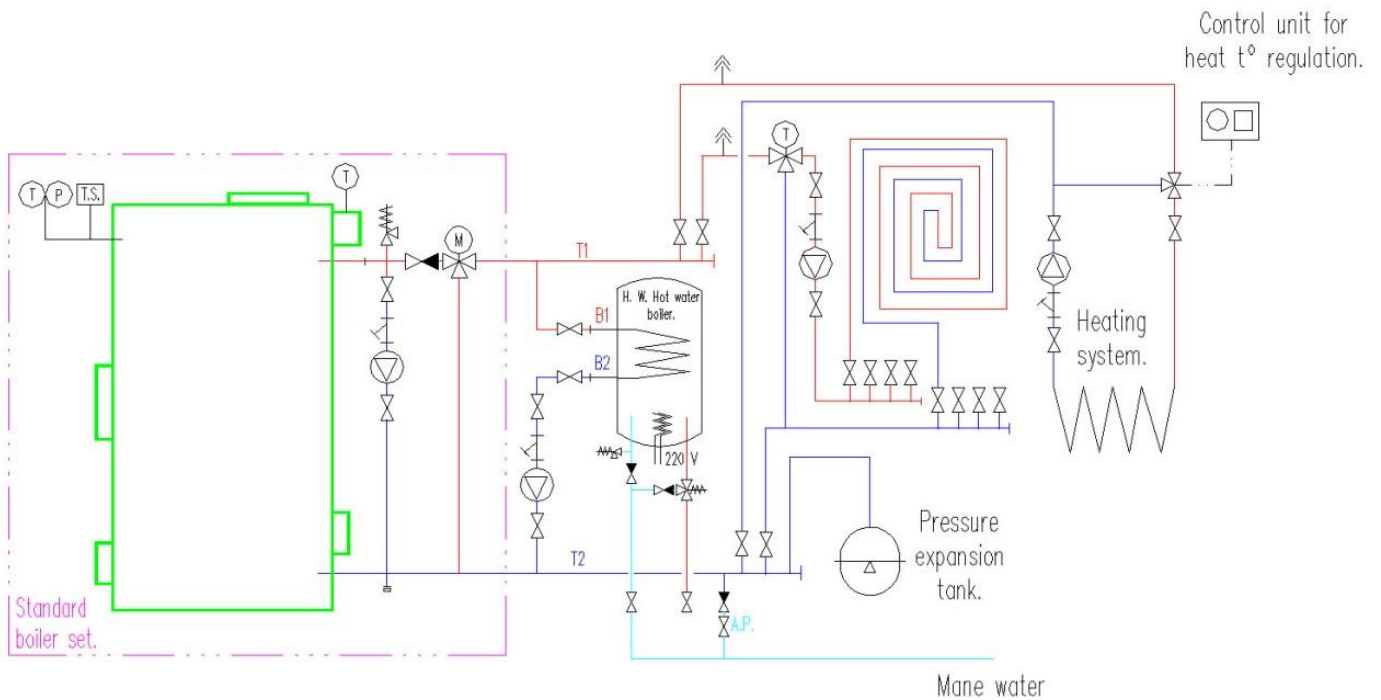

#### Designations:

T1	Water inflow to the heating system		Thermostat
T2	Water outflow from the heating system		Safety valve
B1	Water supply to the boiler		Ball type valve
B2	Water outflow from the boiler		Water filter
	Thermo manometer		Sealing plug
	Thermometer		Pump
	Three way mixing valve		Air bleeder valve

# OPERATION AND INSTALLATION MANUAL

## Boiler Control System Connection Schematic

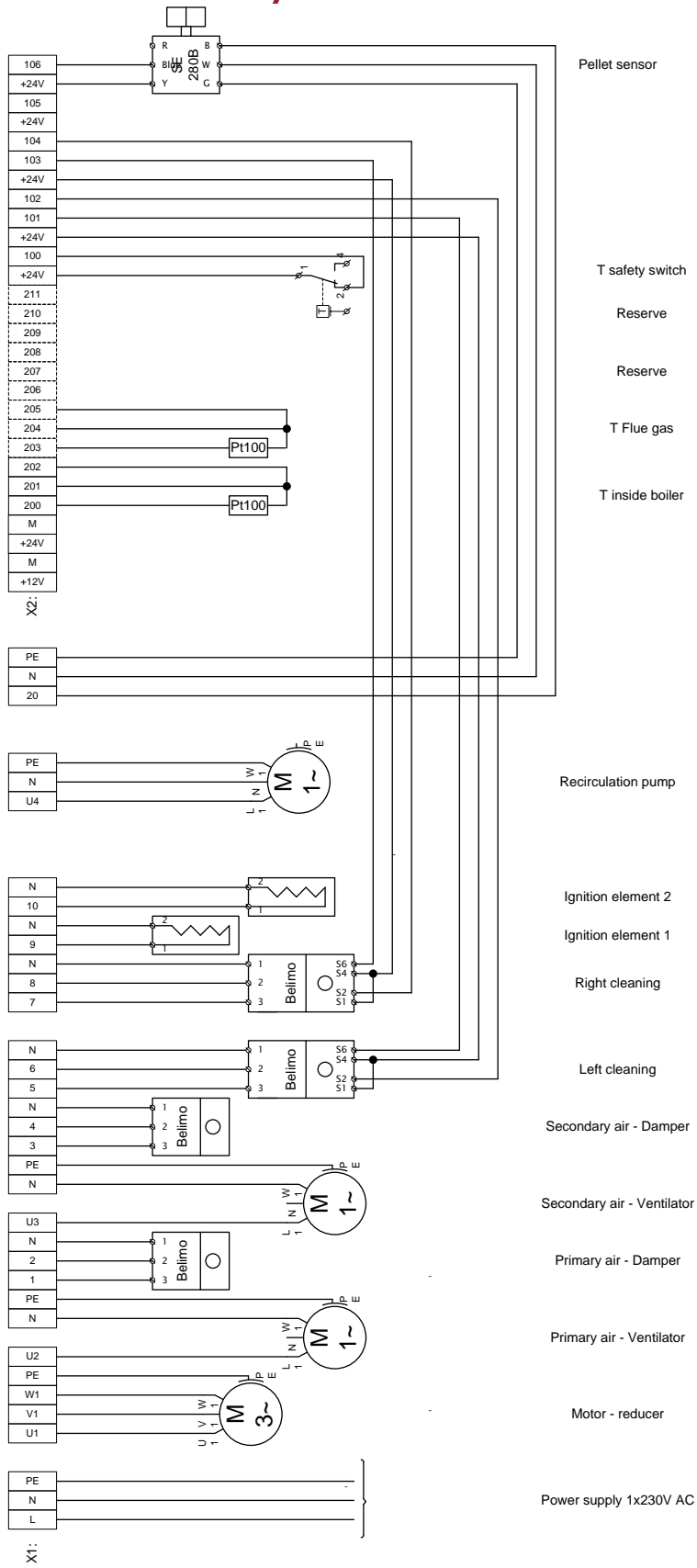

## Installation Process

- Remove protective packaging and fastening.
- Connect pellet heating boiler to heating system, flue pipe, and electrical current.
- Fill up the boiler and heating system with water (carbonate hardness should not exceed 0.7 mg-ekv/l, suspended solids should not exceed 5 mg/l, pH level should not be less than 7).
- Check for heat carrier (water) leakage (it is not recommended to add any antifreeze chemicals to the water that is used as heat carrier).
- Check the boiler pressure (pressure in the boiler should not exceed the allowance).
- Make sure that the boiler is grounded.
- Shut-off valves that disconnect the boiler from heating system must be installed on water inflow and outflow pipes, except on safety valve against overpressure and heat carrier (water) expansion vessel.
- Heating system must be equipped with automatic water pressure monitoring sensor which stops boiler operation in case of absence of required water pressure.
- The pellet heating boiler must be equipped with a recirculation system and three way mixing valve which maintains temperature of the heat carrier entering the boiler (outflow from the heating system) above 65°C (combustion product dew point) in order to avoid the condensation in the boiler and to extend the operational life of the boiler and flue pipes.



It is forbidden to install the boiler in a room with a high level of dust and humidity.



It is forbidden to connect the pellet heating boiler to electricity if all electrical nodes in the boiler have not been connected, or if the boiler has not been filled with heat carrier (water).



It is forbidden to install a valve between the boiler and safety valve as well as between the boiler and expansion vessel.



GRANDEG recommends that a certified service specialist performs the installation of your boiler (Please refer to the Recommended Connection Schematics section)

## Recommendations for Flue Pipe Installation

The pellet heating boiler must be connected to a proper size flue pipe which is insulated and lined. Chimney flue pipe cross-section diameter must be  $\frac{1}{4}$  times bigger than the cross-section diameter of boiler flue starting collar.

### Choice of flue pipes' cross-section diameter:

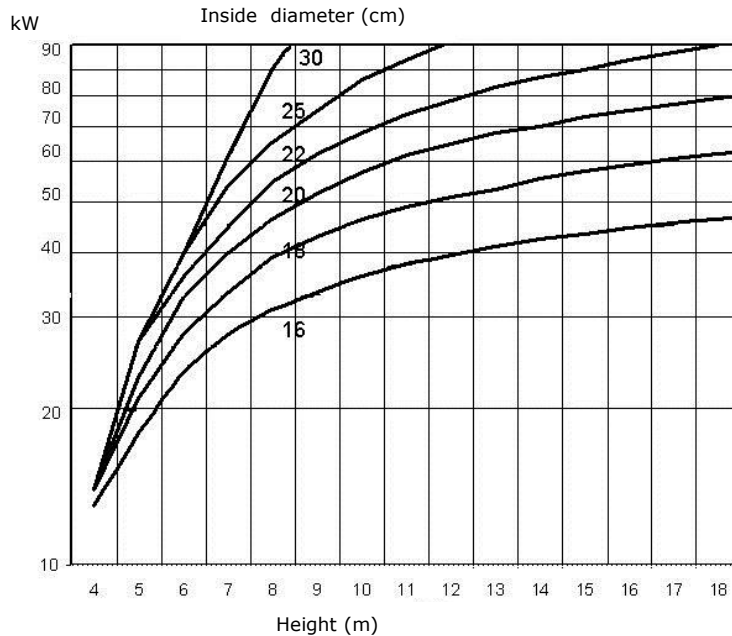

Flue pipes must be always well-maintained – free from soot and condensate and without any cracks and holes.

Masonry chimney must be insulated and lined with a stainless steel shell to protect the flue pipes against condensation or overheating in case of fire. If condensate still forms despite the insulation of the chimney, the stainless steel shell provides its collection without damaging the chimney.

Corrugated stainless steel pipes must not be used for lining of the chimney because their layout surface is twice as large compared to smooth pipes. Corrugated pipes can cool flue gas more intensively and therefore create condensation more quickly. They also create resistance for flue gas flow, collect dust and condensate in greater amount, and are more difficult to clean.

The flue pipe connecting the boiler flue starting collar to the flu pipe system can be several meters high but under the condition that it can be cleaned easily. This pipe must be created from heat-resistant and corrosion-resistant metal. Work temperature of flue gasses can reach from 1500 to 2000 °C, and in case of soot fire – up to 10000 °C. Thus this pipe must be insulated with 50mm thick heat-insulating wool which must be covered with metal folium or tin. All connections must be solid and heat-resistant.

# ***OPERATION AND INSTALLATION MANUAL***

Make sure that your pellet heating boiler flue pipe is not connected to other heating system (appliances), except if constructed for discharge of flue gasses from several heating systems.

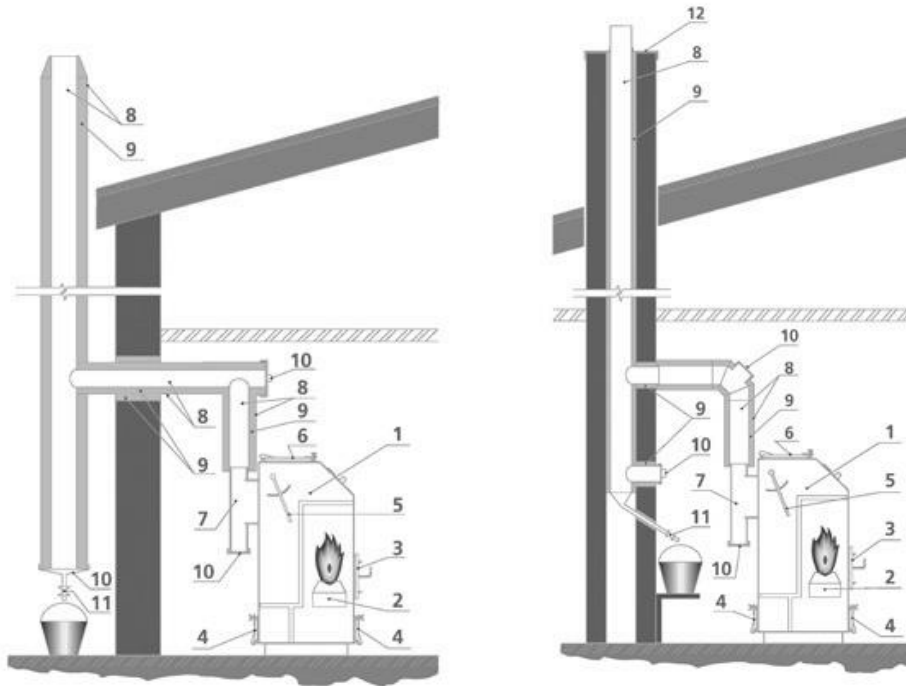

<b>Designations:</b>			
1.	Pellet boiler	7.	Boiler flue
2.	Pellet burner	8.	Stainless steel flue pipe that connects boiler flue to the flue pipe system
3.	Burning chamber door	9.	Heat-resistant insulation
4.	Ash cleaning compartment door	10.	Ash cleaning hatch
5.	Atmospheric valve	11.	Condensate collector
6.	Heat exchanger cleaning door	12.	Sealing plate for the waterproofing insulation/hydroisolation (hidroizolācijas noslēgplāksne)

## **Requirements for Flue Pipe installation**

- Flue pipe must be constructed according to LBN 231-03 regulations or corresponding local standards.
- Flu pipes must be made of heat and corrosion resistant materials and well-insulated.

## ***OPERATION AND INSTALLATION MANUAL***

---

- Flue pipe must provide discharge of overpressure from the boiler to secure smooth discharge of the flue gasses.
- Flue pipe must be equipped with condensate collector.
- Horizontal parts of flue pipe connections must be equipped with hatches for monitoring and cleaning (10).
- Flue pipe must be constructed at least 0.5m above the roof ridge.
- After installation and launch of the pellet heating boiler, all flue pipe connections must be checked for potential exhaust leaks. If necessary, seals must be tightened.
- Natural draft in the flue pipe must be not less than 12 Pa.
- It is forbidden to install a flue pipe connection directly above the flue pipe section that connects the boiler flue starting collar to the rest of the flue pipe system (8) (Please refer to the Recommendations for flue pipe installation).

## **Warranty Terms**



**Please note that the Manufacturer cannot be held liable for any direct, indirect or accidental losses (including loss of profit) which may occur as a result of operation, idleness, defects or standstill of its manufactured heating boiler (Product), even if the Manufacturer has been informed about the possibility of occurrence of such losses.**

### Warranty Items

The Manufacturer provides Warranty Repairs rights for the body of the Product (boiler) which includes:

- The burning chamber section;
- The water circulation section, only if its assembly is maintained as provided by the Manufacturer;
- The flue gas circulation section;
- The ash accumulation section.

The Manufacturer provides Warranty Repairs rights for the body of the Product (please refer to the paragraph above) if the following Defects are detected:

- The burning chamber section – a fracture or leak in the metal and/or a welded joint;
- The water circulation section – a fracture or leak in the metal and/or a welded joint;
- The flue gas circulation section– a fracture or leak in the metal and/or a welded joint;
- The ash accumulation section – a fracture or leak in the metal and/or a welded joint.

The Manufacturer provides Warranty Repairs rights for the electro-mechanical components of the Product (boiler), which include:

- Doors and hatches and their fixating parts;
- The measurement instruments panel section of the boiler;
- The recirculation section of the heating boiler, only for the assembly as supplied by the Manufacturer;
- The decorative siding of the heating boiler;
- The pellet hopper.

The Manufacturer provides Warranty Repairs rights for the electro-mechanical components of the Product, (see section 14.3.) if the following Defects are detected:



## ***OPERATION AND INSTALLATION MANUAL***

- For doors and hatches and their fixating parts - if a fracture in the metal and/or a welded joint occurs;
- For the measurement instruments panel section of the boiler, the three-way valve mechanism - if a fracture and/or a leak in the metal and/or a soldered joint is detected, but only if the assembly is as provided by the manufacturer;
- For the measurement instruments panel section of the boiler, the measurement instruments, the thermostat, thermometers, and the control switch – against industrial faults;
- For the recirculation section of the heating boiler, for the pump and safety valve – against industrial faults, only if the assembly is as provided by the Manufacturer;
- For the recirculation section of the heating boiler – if a fracture in the metal and/or a welded joint occurs, only if the assembly is as provided by the Manufacturer;
- For the decorative siding section of the heating boiler – against industrial defects in the painting of the casing;
- For the pellet hopper – if a fracture in the metal and/or welded joints occurs;
- For the pellet hopper– against industrial defects in the painting of the container.

The Manufacturer does not provide Warranty Repairs rights for those parts and components of the Product, whose wear and tear depends on the circumstances under which the boiler is operated and whose wear and tear cannot be forecasted, and also in the case a section and/or components of the Product have been mechanically damaged. This applies to the following components:

- Seals and sealing ropes of the product doors and lids;
- Wear and tear of parts of the pellet supply mechanism located in the boiler (wear of the screw feeder, wear of the tube, wear of the screw feeders' axis, wear of its centering component, wear of the forwarding screw);
- Pellet burners;
- Ceramic isolation plates;
- Electric components, ignition elements and their parts if these have been damaged due to improper electricity supply.

The Manufacturer does not provide Warranty Repairs rights for the body of the Product in case condensate, resin, slag or damage (corrosion) are detected in the burning chamber.

### Duration of Warranty

- For the body of the heating boiler – 2(two) calendar years.
- For electro-mechanical components – 2(two) calendar years.

The Manufacturer does not provide Warranty Repairs rights if the boiler is not equipped with a thermal valves system or a recirculation system which ensures

that the temperature of the heat carrier (water) returning from the heating system of the building is not lower than 60°C.

## **Warranty Receival Terms**

The Product has been installed in conformity with the recommended water, electricity and flue duct connection schemes that are provided in the Operation and Installation Manual.

The Product has been set-up and commissioned by a service specialist who has been certified by the Manufacturer.

The Product has a recirculation circuit installed with a pump, and this circuit functions autonomously from the heating system.

The boiler house is separated from the living rooms and storage facilities, and is only used for its intended purpose.

The boiler house is equipped with external air supply ventilation that is required for the burning process and with natural draft extractive ventilation.

The boiler house conforms to the regulations LBN 231-23 on heating of buildings and ventilation.

The flue gases are drained in via the foreseen location (a flue pipe in a chimney), which is constructed in line with fire security regulations and technical requirements.

The installed flue pipes and chimneys must be heat-insulated so that the flue gases would not condensate in the duct.

All horizontal sections of the flue pipe must have cleaning hatches.

The flue pipes and chimneys must be constructed from fire-proof, heat-resistant materials that are also resistant against the corrosive effects of flue gases.

The exit door of the boiler house is installed so that it would directly exit into and be opened towards the outer yard.

The boiler house has natural lighting, electric lighting, and a separate electricity supply connection with a packet-type switch next to the entrance door of the boiler house, which allows to centrally shut off the power supply to the boiler house.

The Product as a whole and its components are connected to one another and grounded.

The Product's electricity connection must comply with the effective normative regulations of the respective country.

# **OPERATION AND INSTALLATION MANUAL**

The pressure in the heating system must not be lower than 0.5 bar/cm<sup>2</sup>, and it must not exceed the working pressure of the boiler, which is indicated in the Operation and Installation Manual of the Product.

The heating system is of closed type and it is equipped with deaerators so that accumulated air would automatically be drained from the system.

The heating system uses water as the heat carrier.

The water filled into the heating system and into the boiler must comply with the following norms: carbonate hardness - not more than 700 mg equiv/l; content of suspended particles - not more than 5 mg/l; pH level - not lower than 7.

No changes to the assembly and to the set-up of the Product can be made without the presence of a service specialist who has been certified by the Manufacturer, and all changes must be noted with respective marks in the Operation and Installation Manual of the Product.

The annual maintenance of the Product has been observed and carried out by a service specialist who has been certified by the Manufacturer.

The Client must be able to present the Operation and Installation Manual of the Product as well as its warranty certificate, filled in by the warranty provider.

The Product and its components have been cleaned in line with the terms specified in the Operation and Installation Manual and in the signage on the boiler. If using low-quality fuel material, cleaning routines must be carried 2 (two) times more frequently than specified in the Operation and Installation Manual of the Product.

The Product (heating boiler) is equipped with a certified recirculation system and a burner system, a pellet supply system and an automatics system.

## **Warranty Receival Procedure**

When detecting a technical fault or damage, the Client must contact the Warranty Provider indicated in the Warranty Certificate or their representing Service Specialist, or the company, which has sold (installed) the heating boiler.

The Client must describe the damage as closely as possible so that the Service Specialist can perform diagnostics of the issue and determine the cause of the fault.

The Client must carry out the actions suggested by the Service Specialist in order to correct the fault.

The Service Specialist must inform the Client about all the costs which are related to visiting the Client and performing repairs, in case the detected fault will not

## ***OPERATION AND INSTALLATION MANUAL***

---

comply with the warranty terms set forth in this Operation and Installation Manual.

The Service Specialist must reach agreement with the Client regarding a visiting time to perform repairs.

The Service Specialist must visit the Client and repair the damage no later than 48 hours after receiving a verbal or written call by the Client. In case the detected damage cannot be repaired at that time, the Service Specialist is to agree with the Client on the time and resources required for the repairs.

After performing repair works, the Service Specialist must make a corresponding record in the Operation and Installation Manual of the Product.

The client must ensure alternative heating for the rooms until the Service Specialist arrives, in case there is the possibility that the temperature of the respective premises may fall below 00C.

The Warranty Provider carries full material accountability towards the Client for any losses arising from delayed visiting and repairs of the defect.

# OPERATION AND INSTALLATION MANUAL

## Annex No.1 „Annual Maintenance Form“

No	Action	OK/Notes
1.	Check, whether the boiler house complies with the requirements specified in the Operation and Installation Manual.	
2.	Check if the water, electrical and flue duct connections of the Product comply with the requirements specified in the Operation and Installation Manual.	
<b>3.</b>	<b>External/visual diagnostics of the Product:</b>	
3.1.	Check the condition of the painting;	
3.2.	Check the technical condition of the decorative siding;	
3.3.	Check for corrosion of metal;	
3.4.	Check that the Operation and Installation Manual and the Warranty Certificate are both presented.	
<b>4.</b>	<b>Diagnostics of the body of the Product:</b>	
4.1.	Clean the vertical heat exchanger tubes;	
4.2.	Clean the burning chamber and the burner;	
4.3.	Clean the ash cleaning compartment in the front and in the sides of the boiler;	
4.4.	Visually check all welded joints of the boiler for leaks and corrosion;	
4.5.	Clean the air valve of the burner;	
4.6.	Clean components of the boiler from dust (fan, motor, etc.);	
4.7.	Clean the boiler with a vacuum cleaner, clean the decorative siding of the boiler with a wet cloth.	
<b>5.</b>	<b>Checking and cleaning the flue duct of the Product:</b>	
5.1.	Clean the ash compartment of the flue pipe;	
5.2.	Check the technical condition of the ash compartment hatch and whether it is hermetic;	
5.3.	Check how clean the chimney tube is;	
5.4.	Visually inspect the horizontal flue pipes;	
5.5.	Visually inspect the condition of the chimney of the building.	
<b>6.</b>	<b>Checking the technical condition and adjustment of all doors of the Product:</b>	
6.1.	Check the technical condition and air tightness of the door seals;	
6.2.	Check the technical condition of door hinges and dampers, adjust if necessary;	
6.3.	Check the technical condition of the doors' internal heat insulation material, replace it if needed.	
<b>7.</b>	<b>Checking the technical condition of the Product's recirculation circuit and of the heating system:</b>	
7.1.	Check the operation of the recirculation and heating system circulation pumps in all three states;	
7.2.	Clean the solid particles filters of the recirculation circuit pumps and of the heating system circulation pumps;	

## **OPERATION AND INSTALLATION MANUAL**

7.3.	Check the operation of the overpressure safety valve so that it would not leak under the foreseen working pressure of the system;	
7.4.	Check the technical condition of the shut-off valves (they must not be wet);	
7.5.	Check the connections of the remaining water pipes and the sealing points of fittings (they must not be wet);	
7.6.	Check the water pressure in the system, adjust if necessary;	
7.7.	Check the operation of the automatic air valve and completely bleed the boiler body.	
<b>8.</b>	<b>Checking the measurement instruments panel of the Product:</b>	
8.1.	Check the connections of the water pipes and the sealing of the three way mixing valve (they must not be wet on the outside);	
8.2.	Check the compliance of indicated temperatures with the actual temperatures in the system, adjust indicators if needed;	
8.3.	Check the working and emergency thermostats, adjust if necessary;	
8.4.	Check the boiler control box;	
8.5.	Check the wire connections;	
8.6.	Visually check the condition of cable insulation;	
8.7.	Check the status of electric components and units;	
8.8.	Clean the inside of the boiler control box;	
<b>9.</b>	<b>Checking the pellet supply mechanism</b>	
9.1.	Check all sealings of connections, replace if necessary;	
9.2.	Clean of dust from combustion fan rotor section (blades)	
9.3.	Clean the motor body;	
9.4.	Check the tension and fixation of moving components;	
9.5.	Clean the air supply sections;	
9.6.	Check the condition of the screw feeder	
9.7.	Check the condition of the bearings;	
9.8.	Adjust the supply of air and fuel material;	
9.9.	Check the sealing of the pellet hopper;	
9.10.	Check the visual condition of the pellet hopper;	
9.11.	Clean and wash the outer parts of the product.	
<b>10.</b>	<b>Concluding the Servicing procedure:</b>	
10.1.	Make notes in the Operation and Installation Manual regarding the performed Annual Maintenance procedure;	
10.2.	Make notes in the Operation and Installation Manual, listing all non-conformities;	
10.3.	Receive the Client's confirmation on the adequacy of performed works in the form their signature;	
10.4.	Repeatedly inform about the operation of the Product.	

# **OPERATION AND INSTALLATION MANUAL**

## **Annex No.2**

### **„Notes on Performed Annual Maintenance“**

First set-up and commissioning of the boiler:

Works performed:	
Service Specialist:	
Client: _____ / _____ / Date: _____	

Reason for the call:	
Detected problems:	
Works performed:	
Service Specialist:	
Client: _____ / _____ / Date: _____	

# OPERATION AND INSTALLATION MANUAL

## Annex No.3

### „Cleaning log for Turbo series pellet heating boiler“

Cleaning	Lambda probe	Heat exchanger	Ignition element	Burning chamber	The lower section of the boiler (4 hatches)	Amount of slag (kg)	Type of pellets, quantity	Issues
Date								
Example 22.09.09.	Example X	Example X	Example X	Example X	Example X		Example T.J. Boiler!	





# Warranty Certificate

No \_\_\_\_\_

<b>Client:</b>	
<b>Personal ID/Reg. No:</b>	
<b>Product model:</b>	TURBO-
<b>Product number:</b>	
<b>Product operation address:</b>	
I hereby confirm that I have read and understood the Terms of Operation of the Product as well as the Terms of Warranty of the Product, which are described in detail in the Product Operation and Installation Manual.	
Date: ____/____/____	
_____ / _____	_____ / _____
Signature	Signer

<b>Warranty Provider</b>	
<b>Company:</b>	SIA "Grandeg serviss"
<b>Reg. No:</b>	LV44103053549
<b>Contact person:</b>	Gatis Rebāns, mob.:+371 26318998
I hereby confirm that the Product is installed, connected and set up in accordance with the Technical requirements of the Product and that the Client is entitled to Warranty Repairs of the Product in accordance with the terms described in the Operation and Installation Manual of the Product.	
Date: ____/____/____	
_____ / Gatis Rebāns/	
Signature	Signer

# **OPERATION AND INSTALLATION MANUAL**

## **SIA GRANDEG**

By presenting this Warranty Certificate, the Client is entitled to demand that the Warranty Provider replace or repair the damaged components without any additional payment, in accordance with the Terms of Warranty that are described in detail in the „Terms of Warranty“ section of the Operation and Installation Manual of the Product.

Date: \_\_\_/\_\_\_/\_\_\_

\_\_\_\_\_ / \_\_\_\_\_ /

Signature      Signer