

Heating

Technical Data

Daikin Altherma low temperature split



EEDEN12-725

ERLQ-CW1

TABLE OF CONTENTS

ERLQ-CW1

1	Features	2
2	Specifications	3
	Connectable indoor units	3
	Technical Specifications	4
	Electrical Specifications	5
3	Options	7
	Options	7
4	Capacity tables	8
	Heating Capacity Tables	8
	Cooling Capacity Tables	10
5	Dimensional drawings	11
	Dimensional Drawings	11
6	Centre of gravity	12
	Centre of Gravity	12
7	Piping diagrams	13
	Piping Diagrams	13
8	Wiring diagrams	14
	Wiring Diagrams - Three Phase	14
9	Sound data	15
	Sound Pressure Spectrum - Heating	15
	Sound Pressure Spectrum - Cooling	16
	Sound Pressure Spectrum Quiet Mode	17
10	Installation	18
	Installation Method	18
11	Operation range	20
	Operation Range	20

1 Features

- Energy efficient heating system based on air source heat pump technology
- Cost effective alternative to a fossil fuel boiler
- Low energy bills and low CO2 emissions
- Easy to install

1



2 Specifications

2-1 Connectable indoor units				EHBH16C3V/ ERLQ011CW1	EHBH16C9W/ ERLQ011CW1	EHBH16C3V/ ERLQ014CW1	EHBH16C9W/ ERLQ014CW1	EHBH16C3V/ ERLQ016CW1	EHBH16C9W/ ERLQ016CW1		
Heating capacity	Nom.			kW		11.38 (1)		14.55 (1)		16.10 (1)	
Power input	Heating	Nom.		kW		2.64		3.43		3.83	
COP						4.31		4.24		4.20	
Pump	Nominal ESP unit	Heating		kPa		86 (1) / 88 (2)	86 (1) / 88 (2)	47 (1) / 59 (2)	47 (1) / 59 (2)	26 (1) / 38 (2)	26 (1) / 38 (2)
Water side Heat exchanger	Water flow rate	Heating	Nom.	l/min		32.1 (1) / 31.5 (2)	32.1 (1) / 31.5 (2)	41.6 (1) / 39 (2)	41.6 (1) / 39 (2)	45.9 (1) / 43.6 (2)	45.9 (1) / 43.6 (2)

Notes

(1) DB/WB 7°C/6°C - LWC 35°C (DT=5°C)

(2) DB/WB 7°C/6°C - LWC 45°C (Dt=5°C)

2-2 Connectable indoor units				EHBX16C3V/ ERLQ011CW1	EHBX16C9W/ ERLQ011CW1	EHBX16C3V/ ERLQ014CW1	EHBX16C9W/ ERLQ014CW1	EHBX16C3V/ ERLQ016CW1	EHBX16C9W/ ERLQ016CW1		
Heating capacity	Nom.			kW		11.38 (3)		14.55 (3)		16.10 (3)	
Cooling capacity	Nom.			kW		11.72 (1)		12.55 (1)		13.12 (1)	
Power input	Heating	Nom.		kW		2.64		3.43		3.83	
	Cooling	Nom.		kW		4.31		5.09		5.74	
COP						4.31		4.24		4.20	
EER						2.72		2.47		2.29	
Pump	Nominal ESP unit	Cooling		kPa		80 (1) / 40 (2)	80 (1) / 40 (2)	71 (1) / 26 (2)	71 (1) / 26 (2)	65 (1) / 16 (2)	65 (1) / 16 (2)
		Heating		kPa		86 (3) / 88 (4)	86 (3) / 88 (4)	47 (3) / 59 (4)	47 (3) / 59 (4)	26 (3) / 38 (4)	26 (3) / 38 (4)
Water side Heat exchanger	Water flow rate	Cooling	Nom.	l/min		33.6 (1) / 43.1 (2)	33.6 (1) / 43.1 (2)	36.0 (1) / 46.0 (2)	36.0 (1) / 46.0 (2)	37.6 (1) / 48.0 (2)	37.6 (1) / 48.0 (2)
		Heating	Nom.	l/min		32.1 (3) / 31.5 (4)	32.1 (3) / 31.5 (4)	41.6 (3) / 39.0 (4)	41.6 (3) / 39.0 (4)	45.9 (3) / 43.6 (4)	45.9 (3) / 43.6 (4)

Notes

(1) Tamb 35°C - LWE 7°C (DT=5°C)

(2) Tamb 35°C - LWE 18°C (DT=5°C)

(3) DB/WB 7°C/6°C - LWC 35°C (DT=5°C)

(4) DB/WB 7°C/6°C - LWC 45°C (Dt=5°C)

2-3 Connectable indoor units				EHVH16S18C3V /ERLQ011CW1	EHVH16S26C9 W/ ERLQ011CW1	EHVH16S18C3V /ERLQ014CW1	EHVH16S26C9 W/ ERLQ014CW1	EHVH16S18C3V /ERLQ016CW1	EHVH16S26C9 W/ ERLQ016CW1		
Heating capacity	Nom.			kW		11.38 (1)		14.55 (1)		16.10 (1)	
Power input	Heating	Nom.		kW		2.64		3.43		3.83	
COP						4.31		4.24		4.20	
Pump	Nominal ESP unit	Heating		kPa		83.6 (1) / 85.8 (2)	83.6 (1) / 85.8 (2)	44.1 (1) / 55.9 (2)	44.1 (1) / 55.9 (2)	23.1 (1) / 34.6 (2)	23.1 (1) / 34.6 (2)
Water side Heat exchanger	Water flow rate	Heating	Nom.	l/min		32.1 (1) / 31.5 (2)	32.1 (1) / 31.5 (2)	41.6 (1) / 39.0 (2)	41.6 (1) / 39.0 (2)	45.9 (1) / 43.6 (2)	45.9 (1) / 43.6 (2)

Notes

(1) DB/WB 7°C/6°C - LWC 35°C (DT=5°C)

(2) DB/WB 7°C/6°C - LWC 45°C (Dt=5°C)

2-4 Connectable indoor units				EHVX16S18C3V /ERLQ011CW1	EHVX16S26C9 W/ ERLQ011CW1	EHVX16S18C3V /ERLQ014CW1	EHVX16S26C9 W/ ERLQ014CW1	EHVX16S18C3V /ERLQ016CW1	EHVX16S26C9 W/ ERLQ016CW1		
Heating capacity	Nom.			kW		11.38 (3)		14.55 (3)		16.10 (3)	
Cooling capacity	Nom.			kW		11.72 (1)		12.55 (1)		13.12 (1)	
Power input	Heating	Nom.		kW		2.64		3.43		3.83	
	Cooling	Nom.		kW		4.31		5.09		5.74	
COP						4.31		4.24		4.20	
EER						2.72		2.47		2.29	

2 Specifications

2

2-4 Connectable indoor units				EHVX16S18C3V /ERLQ011CW1	EHVX16S26C9 W/ ERLQ011CW1	EHVX16S18C3V /ERLQ014CW1	EHVX16S26C9 W/ ERLQ014CW1	EHVX16S18C3V /ERLQ016CW1	EHVX16S26C9 W/ ERLQ016CW1	
Pump	Nominal ESP unit	Cooling		kPa	78.0 (1) / 37.0 (2)	78.0 (1) / 37.0 (2)	68.6 (1) / 22.5 (2)	68.6 (1) / 22.5 (2)	61.9 (1) / 12.1 (2)	61.9 (1) / 12.1 (2)
		Heating		kPa	83.6 (3) / 85.8 (4)	83.6 (3) / 85.8 (4)	44.1 (3) / 55.9 (4)	44.1 (3) / 55.9 (4)	23.1 (3) / 34.6 (4)	23.1 (3) / 34.6 (4)
Water side Heat exchanger	Water flow rate	Cooling	Nom.	l/min	33.6 (1) / 43.1 (2)	33.6 (1) / 43.1 (2)	36.0 (1) / 46.0 (2)	36.0 (1) / 46.0 (2)	37.6 (1) / 48.0 (2)	37.6 (1) / 48.0 (2)
		Heating	Nom.	l/min	32.1 (3) / 31.5 (4)	32.1 (3) / 31.5 (4)	41.6 (3) / 39.0 (4)	41.6 (3) / 39.0 (4)	45.9 (3) / 43.6 (4)	45.9 (3) / 43.6 (4)

Notes

- (1) Tamb 35°C - LWE 7°C (DT=5°C)
- (2) Tamb 35°C - LWE 18°C (DT=5°C)
- (3) DB/WB 7°C/6°C - LWC 35°C (DT=5°C)
- (4) DB/WB 7°C/6°C - LWC 45°C (Dt=5°C)

2-5 Technical Specifications				ERLQ011CW1	ERLQ014CW1	ERLQ016CW1
Capacity control	Method			Inverter controlled		
Casing	Colour			Ivory white		
	Material			Painted galvanized steel plate		
Dimensions	Unit	Height	mm	1,345		
		Width	mm	900		
		Depth	mm	320		
	Packed unit	Height	mm	1,524		
		Width	mm	980		
		Depth	mm	420		
Weight	Unit		kg	114		
	Packed unit		kg	129		
Packing	Material			Wood / Carton / EPS / PE (Straps)	Wood / Carton / EPS / PE (Straps)	Wood / Carton / EPS / PE (Straps)
	Weight			kg	15	
Heat exchanger	Length		mm	857		
	Rows	Quantity		2		
	Fin pitch		mm	1.4		
	Passes	Quantity		7		
	Face area		m ²	1.131		
	Stages	Quantity		60		
	Empty tubeplate hole	Quantity		0		
	Tube type			ø8 Hi-XSS		
	Fin	Type		WF fin		
		Treatment		Anti-corrosion treatment (PE)		
	Fan	Type			Propeller fan	
Quantity			2			
Discharge direction			Horizontal			
Fan motor	Quantity			2		
	Model			Brushless DC motor		
	Output		W	70		
	Drive			Direct drive		
	Speed	Steps		8		
Heating		Nom.	rpm	740	750	760
Cooling		Nom.	rpm	780		

2 Specifications

2-5 Technical Specifications				ERLQ011CW1	ERLQ014CW1	ERLQ016CW1
Compressor	Quantity			1		
	Model			JT1G-VDYR (B2)		
	Type			Hermetically sealed scroll compressor		
	Output		W	2,200		
	Starting method			Inverter driven		
	Motor	Crankcase heater	Output	W	33	
Operation range	Heating	Min.	°CWB	-25		
		Max.	°CWB	35		
	Cooling	Min.	°CDB	10		
		Max.	°CDB	46		
	Domestic hot water	Min.	°CDB	-20		
		Max.	°CDB	35		
Refrigerant	Type			R-410A		
	Charge		kg	3.4		
	Control			Expansion valve (electronic type)		
	Circuits	Quantity		1		
Refrigerant oil	Type			Daphne FVC68D		
	Charged volume		l	1.5		
Piping connections	Liquid	Quantity			1	
		Type			Flare connection	
		OD	mm		9.52	
	Gas	Quantity			1	
		Type			Flare connection	
		OD	mm		15.9	
	Drain	Quantity			3	
		Type			Hole	
		OD	mm		26	
	Drain 2	Quantity			1	
		Type			Hole	
		OD	mm		18	
	Piping length	OU - IU	Max.	m	50	
		System	Equivalent	m	70	
			Chargeless	m	10	
	Additional refrigerant charge			kg/m	See installation manual	
Level difference	IU - OU	Max.	m	30		
Heat insulation			Both liquid and gas pipes			
Sound power level	Heating	Nom.	dBA	64	66	
	Cooling	Nom.	dBA	64	69	
Sound pressure level	Heating	Nom.	dBA	51	52	
	Cooling	Nom.	dBA	50	54	
	Night quiet mode	Heating	dBA	42	43	
		Cooling	dBA	45	46	
Defrost method			Pressure equalising			
Defrost control			Sensor for outdoor heat exchanger temperature			
Safety devices	Item	01	High pressure switch			
		02	Fan motor thermal protection			
		03	Fuse			

2-6 Electrical Specifications				ERLQ011CW1	ERLQ014CW1	ERLQ016CW1
Power supply	Name			W1		
	Phase			3N~		
	Frequency		Hz	50		
	Voltage		V	400		
	Voltage range	Min.	%	-10		
		Max.	%	10		

2 Specifications

2

2-6 Electrical Specifications				ERLQ011CW1	ERLQ014CW1	ERLQ016CW1
Current	Maximum running current	Heating	A	16.3		
		Cooling	A	16.3		
	Recommended fuses		A	20		
Wiring connections	For power supply	Remark	See installation manual outdoor unit			
	For connection with indoor	Remark	See installation manual outdoor unit			
Power supply intake				Outdoor unit only		

Notes

- (1) The sound pressure level is measured via a microphone at a certain distance from the unit. It is a relative value depending on the distance and acoustic environment. Refer to sound spectrum drawing for more information.
- (2) Condition: Ta DB/WB 7°C/6°C - LWC 35°C (DT = 5°C)
- (3) Condition: Ta 35°C - LWE 7°C (DT = 5°C)
- (4) Operation range domestic hot water (outdoor unit): range increase by support booster heater
- (5) Operation range heating (outdoor unit): range increase by support back-up heater
- (6) See separate drawing for operation range
- (7) European/International Technical Standard setting the limits for harmonic currents produced by equipment connected to public low-voltage systems with input current $I > 16A$ and $I \leq 75A$ per phase

3 Options

3 - 1 Options

ERLQ011-016C

Outdoor combination table for *KHB(H/X)016B*

		RLQ011C(V3/W1)	*RLQ014C*(V3/W1)	*RLQ016C*(V3/W1)
KHBH016AA/BA	Heating only indoor unit	●(1)	●(1)	●(1)
KHBX016AA/BA	Reversible indoor unit	●(1)	●(1)	●(1)
KHBH016BB	Heating only indoor unit	●	●	●
KHBX016BB	Reversible only indoor unit	●	●	●

Kit availability for *RLQ011-016C*

		*RLQ011C*V3	*RLQ014C*V3	*RLQ016CC*V3	*RLQ011C*W1	*RLQ014C*W1	*RLQ016CC*W1
*K016SNC (2)	Snow cover	●	●	●	●	●	●
KRP58M51 (3)	Demand PCB	●	●	●	—	—	—
KRP58M51 (3)	Demand PCB	—	—	—	●	●	●

NOTES

- 1 Combination is possible and allowed. Not all functionalities of ERLQ011~016C* will be available (increased DHW operation range)
- 2 It is very important to select an installation site when the snow will not affect the unit.
If lateral snowfall is possible, snow cover is recommended or make sure that the heat exchanger coil is not affected by the snow.
(See "Installation service space" and "Installation guideline/precaution outdoor")
- 3 This demand PCB option is only applicable for the "Setting of demand running"

3TW60339-4

4 Capacity tables

4 - 1 Heating Capacity Tables

ERLQ011-016C

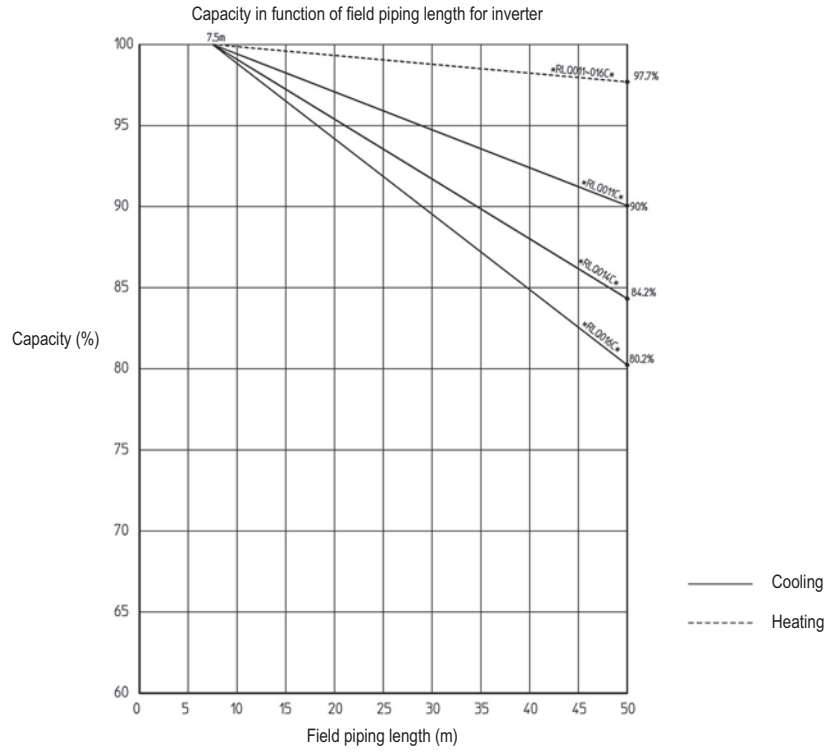

NOTE

Capacity drop is at nominal capacity

3TW60332-5A

4 Capacity tables

4 - 2 Cooling Capacity Tables

ERLQ-CW1

Maximum cooling capacity

LWE [°C]	Tamb [°C]	20		25		30		35		40		45	
		CC [kW]	PI [kW]	CC [kW]	PI [kW]	CC [kW]	PI [kW]	CC [kW]	PI [kW]	CC [kW]	PI [kW]	CC [kW]	PI [kW]
RLQ011	7	12,99	3,26	12,88	3,57	12,44	3,92	11,72	4,31	10,74	4,74	9,54	5,22
	10	13,79	3,29	13,67	3,61	13,20	3,97	12,44	4,37	11,40	4,81	10,14	5,30
	13	15,16	3,33	15,02	3,65	14,51	4,02	13,67	4,43	12,54	4,88	11,00	5,54
	15	16,10	3,35	15,95	3,68	15,41	4,05	14,52	4,47	13,33	4,92	11,40	5,41
	18	17,77	3,38	17,18	3,72	16,26	4,11	15,05	4,53	13,61	4,99	11,54	5,00
	22	19,82	3,43	19,17	3,78	18,16	4,18	16,83	4,61	15,23	5,08	12,10	4,47
RLQ014	7	13,92	3,88	13,81	4,23	13,34	4,63	12,55	5,09	11,13	4,88	9,85	5,37
	10	14,98	3,94	14,85	4,30	14,34	4,71	13,49	5,18	11,97	4,96	10,61	5,46
	13	16,45	4,01	16,30	4,38	15,74	4,79	14,81	5,27	13,15	5,05	11,00	5,54
	15	17,46	4,05	17,30	4,43	16,71	4,85	15,73	5,33	13,97	5,11	11,40	5,41
	18	19,00	4,12	18,36	4,50	17,37	4,94	16,06	5,42	14,05	5,19	11,54	5,00
	22	21,16	4,21	20,45	4,61	19,36	5,06	17,93	5,55	15,71	5,31	12,10	4,47
RLQ016	7	14,55	4,39	14,46	4,79	13,98	5,24	13,12	5,74	11,59	5,48	9,85	5,37
	10	15,67	4,48	15,56	4,89	15,02	5,34	14,09	5,85	12,45	5,58	10,61	5,46
	13	17,22	4,57	17,08	4,99	16,48	5,45	15,47	5,96	13,67	5,68	11,00	5,54
	15	18,29	4,63	18,13	5,06	17,49	5,52	16,42	6,04	14,52	5,75	11,40	5,41
	18	19,91	4,73	19,23	5,16	18,17	5,63	16,76	6,15	14,60	5,85	11,54	5,00
	22	22,18	4,86	21,42	5,30	20,25	5,79	18,69	6,31	16,31	5,99	12,10	4,47

Symbols:

- CC Cooling capacity at maximum operating frequency, measured acc. EN14511
- PI Power input, measured acc. EN14511
- LWE Leaving Water Evaporator temperature
- LWC Leaving Water Condensor temperature
- Tamb Ambient temperature; RH (heating) = 85%

Notes:

- The bottom plate heater is controlled by outdoor unit (linked at defrost operation) and power input is included
- The capacity and power input is valid for V3-models at 230V or W1-models at 400V
- The capacity and power input for Ta ≤ 7°C is at maximum operation and power input 100%
- The capacity and power input for Ta > 7°C is at nominal operation (nominal = maximum)

5 Dimensional drawings

5 - 1 Dimensional Drawings

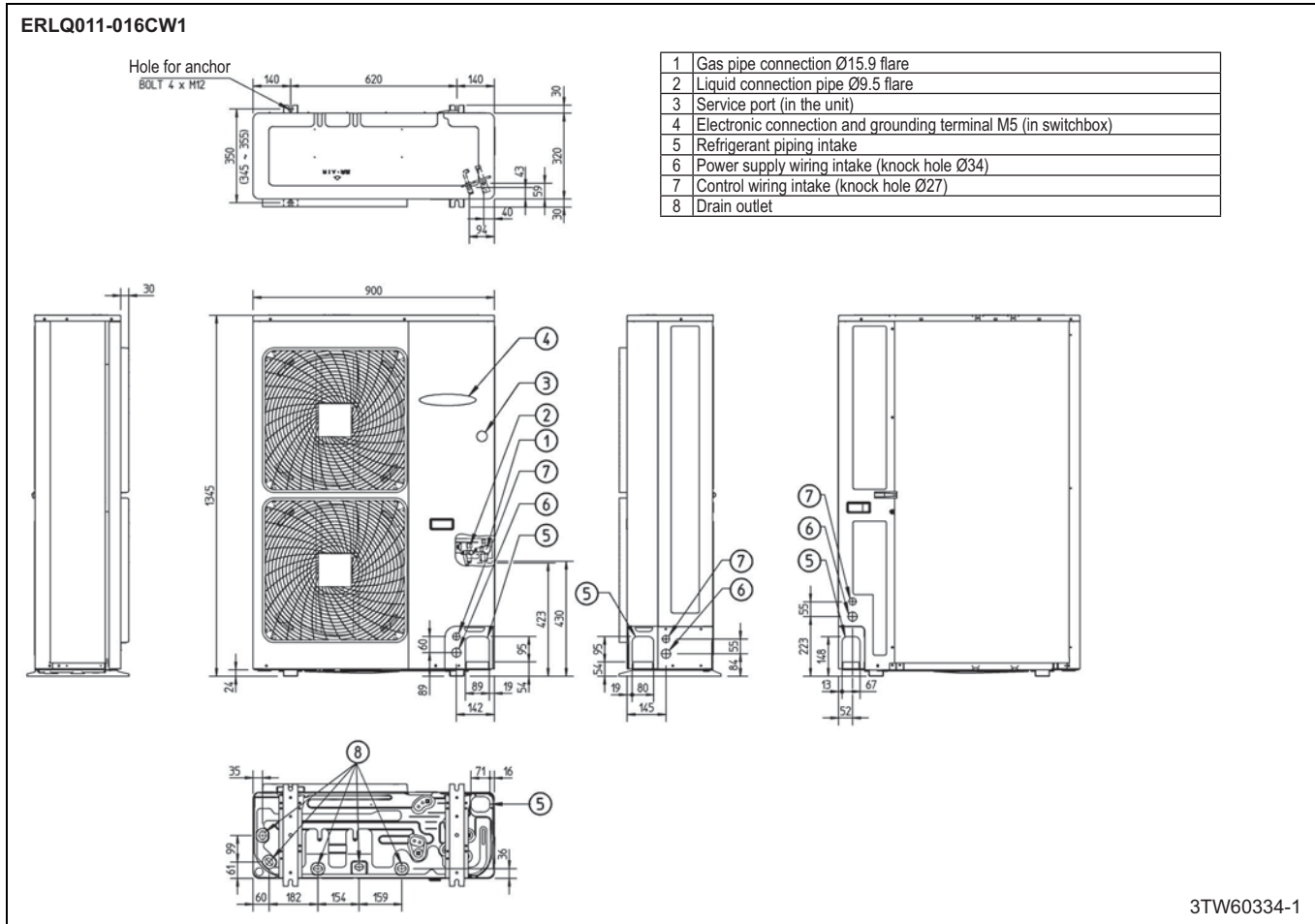

6 Centre of gravity

6 - 1 Centre of Gravity

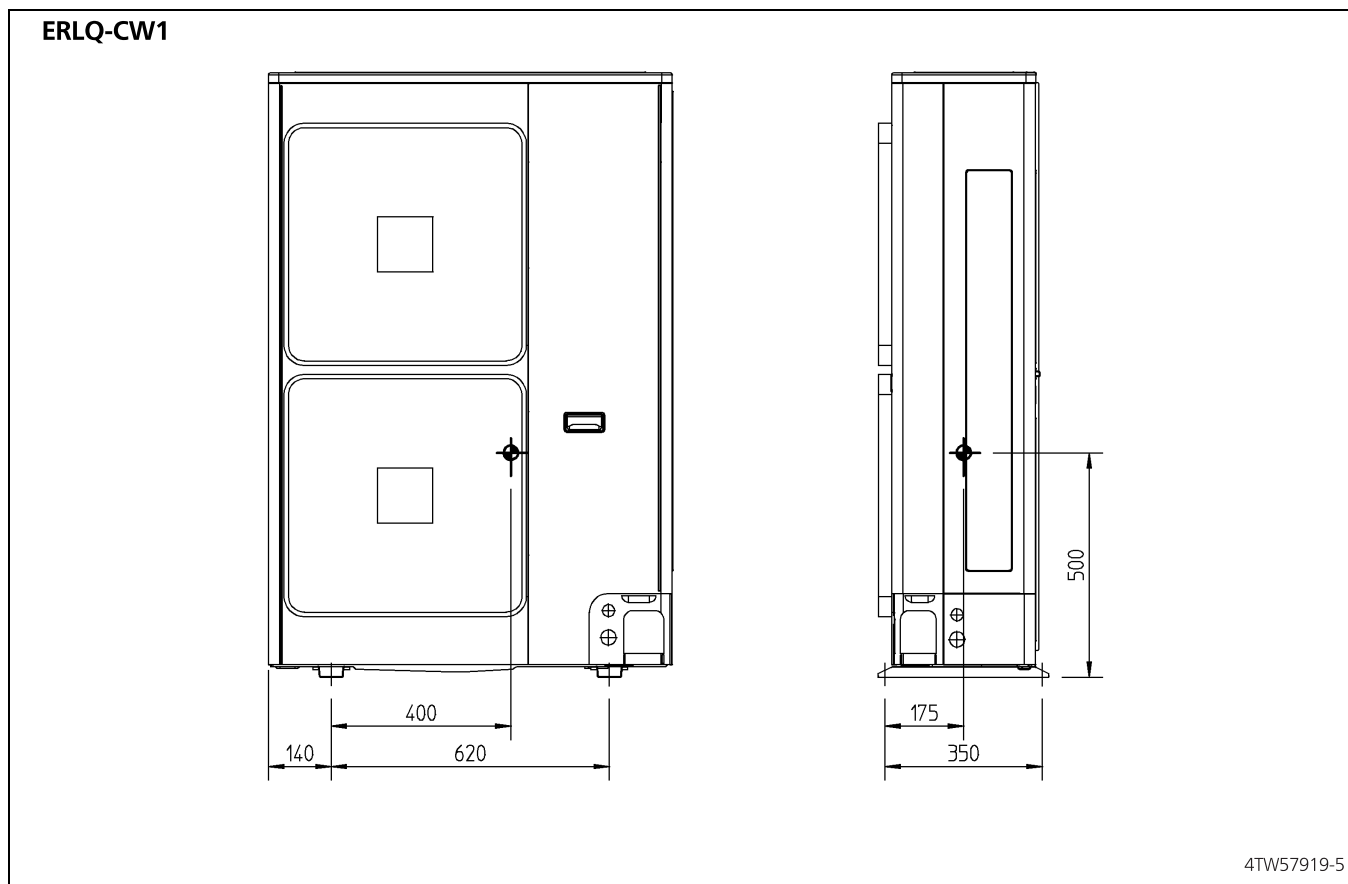

7 Piping diagrams

7 - 1 Piping Diagrams

ERLQ011-016C

R1T	Thermistor (air)
R2T	Thermistor (Discharge)
R3T	Thermistor (Suction)
R4T	Thermistor (Hex)
R5T	Thermistor (Middle hex)
R6T	Thermistor (Liquid)
S1NPH	Pressure sensor
Y1E	Electronic expansion valve (Main)
Y3E	Electronic expansion valve (RU)
E1HC	Crankcase heater
Y1S	4 way valve
Y3S	Solenoid valve (Hot gas pass)
S1PH	High pressure switch
M1F	Fan motor
M1C	Compressor

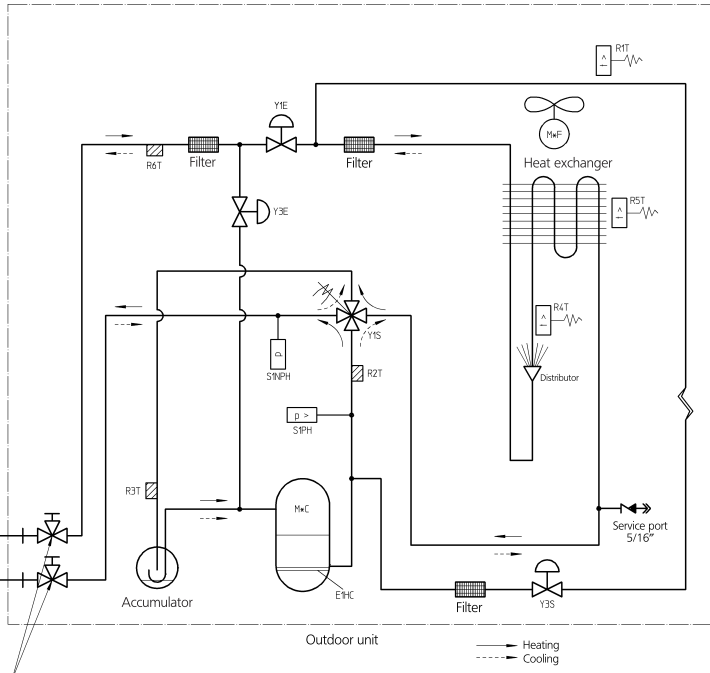

- ⊘ Check valve
 - ↔ Flare connection
 - ⊕ Screw connection
 - ⊔ Flange connection
 - ⊗ Rinsed pipe
 - Spinned pipe
 - ⊗ Motor operated valve
- Stop valve (with service port 5/16" flare)
- Heating
 - - - - - Cooling

3TW60335-1

8 Wiring diagrams

8 - 1 Wiring Diagrams - Three Phase

ERLQ011-016CW1

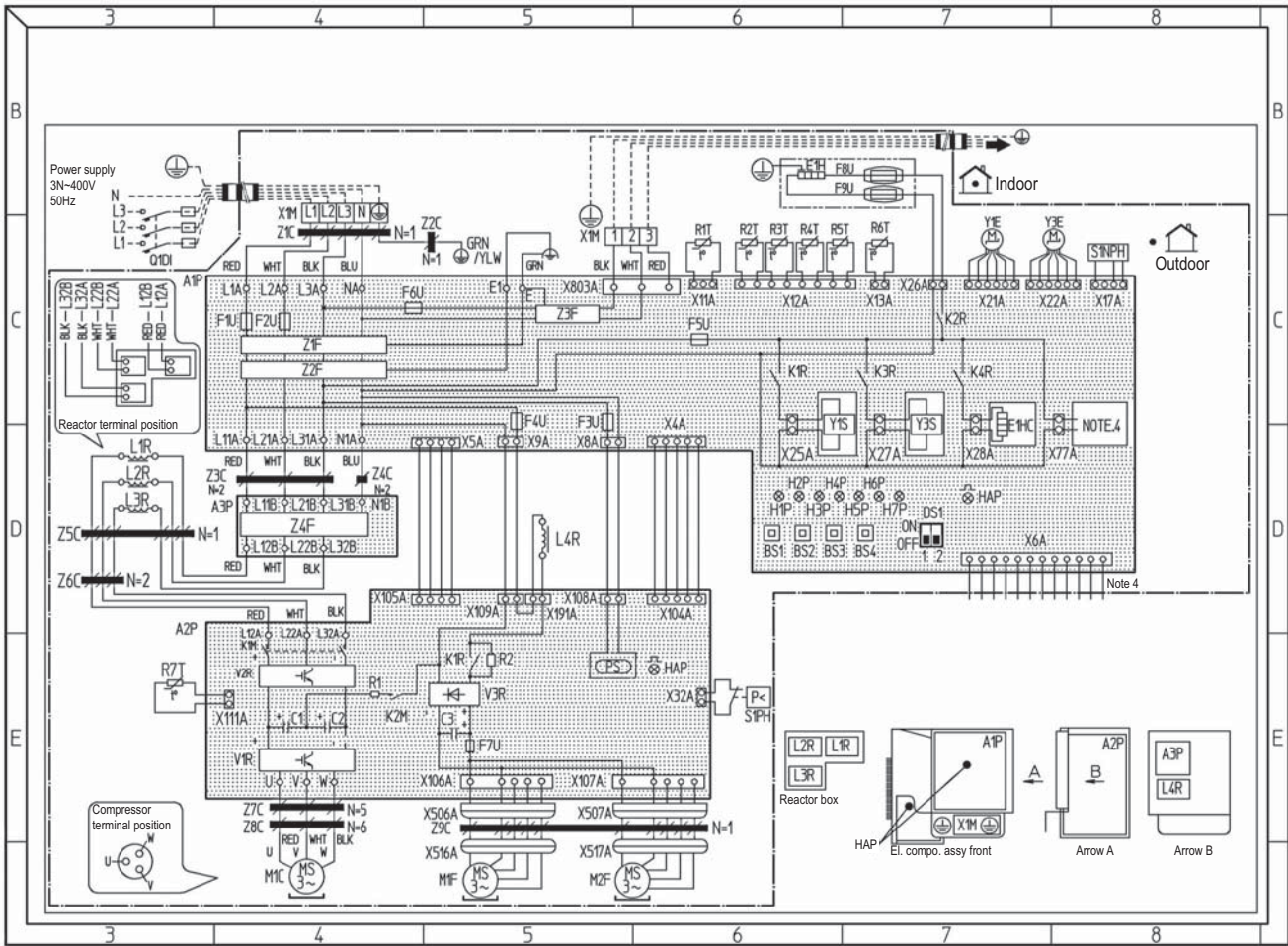

A1P	Printed circuit board (control)	H1P~7P (A1P)	Pilot lamp (service monitor-orange)	R5T	Thermistor (heat exchanger middle)
A2P	Printed circuit board (inv)	K1M-K2M	Magnetic contactor (main - upload)	R6T	Thermistor (liquid)
A3P	Printed circuit board (noise filter)	K1R (A1P)	Magnetic relay (Y1S)	R7T	Thermistor (fin)
BS1-BS4	Push button switch	K1R (A2P)	Magnetic relay (upload)	S1NPH	Pressure sensor
C1~C4	Capacitor	K2R (A1P)	Magnetic relay (E1H)	SPH	Pressure switch (high)
DS1	Dip switch	K3R (A1P)	Magnetic relay (Y3S)	V1R,V2R	Power module
E1HC	Crankcase heater	K4R (A1P)	Magnetic relay (E1HC)	V3R	Diode module
E1H	Bottomplate heater	L1R~L3R	Reactor	X1M	Terminal strip
F1U	Fuse (31.5A / 500V)	L4R	Reactor (for outdoor fan motor)	Y1E	Electronic expansion valve (main)
F2U	Fuse (31.5A / 500V)	M1C	Motor (compressor)	Y3E	Electronic expansion valve (inj)
F3U	Fuse (T 6.3A / 250V)	M1F	Motor (fan) (upper)	Y1S	Solenoid valve (4 way valve)
F4U	Fuse (T 6.3A / 250V)	M2F	Motor (fan) (lower)	Y3S	Solenoid valve (hot gas pass)
F5U	Fuse (T 6.3A / 250V)	PS	Switching power supply	Z1C~Z3C	Noise filter
F6U	Fuse (T 6.3A / 250V)	R1~R4	Resistor	Z1F~Z4F	Noise filter
F7U	Fuse (T 5.0A / 250V)	R1T	Thermistor (air)	Q1DI	Earth leakage circuit breaker
F8U,F9U	Fuse (F 1.0A / 250V)	R2T	Thermistor (discharge)		Optional connector
HAP (A1P)	Pilot lamp (service monitor-green)	R3T	Thermistor (suction)	X6A	Connector
HAP (A2P)	Pilot lamp (service monitor-green)	R4T	Thermistor (heat exchanger)	X77A	Connector

2TW60336-1

NOTES

- This wiring diagram only applies to the outdoor unit
- L: live, N: neutral, : field wiring
- : terminal strip, : connector, : connection, : protective earth (screw), : noiseless earth, : terminal
- Refer to the option manual, for connecting wiring to X6A and X77A.
- Refer to the 'wiring diagram sticker' (on back of front plate) on how to use BS1~BS4 and DS1 switch
- Do not operate the unit by short-circuiting protection device S1PH
- Colors: BLU= blue, BRN= brown, GRN= green, RED= red, WHT= white, YLW= yellow, ORG= orange, BLK= black
- Confirm the method of setting the selector switches (DS1) by service manual; Factory setting of all switches: "off"
- : option, : wiring dependent on model

9 Sound data

9 - 1 Sound Pressure Spectrum - Heating

Heating

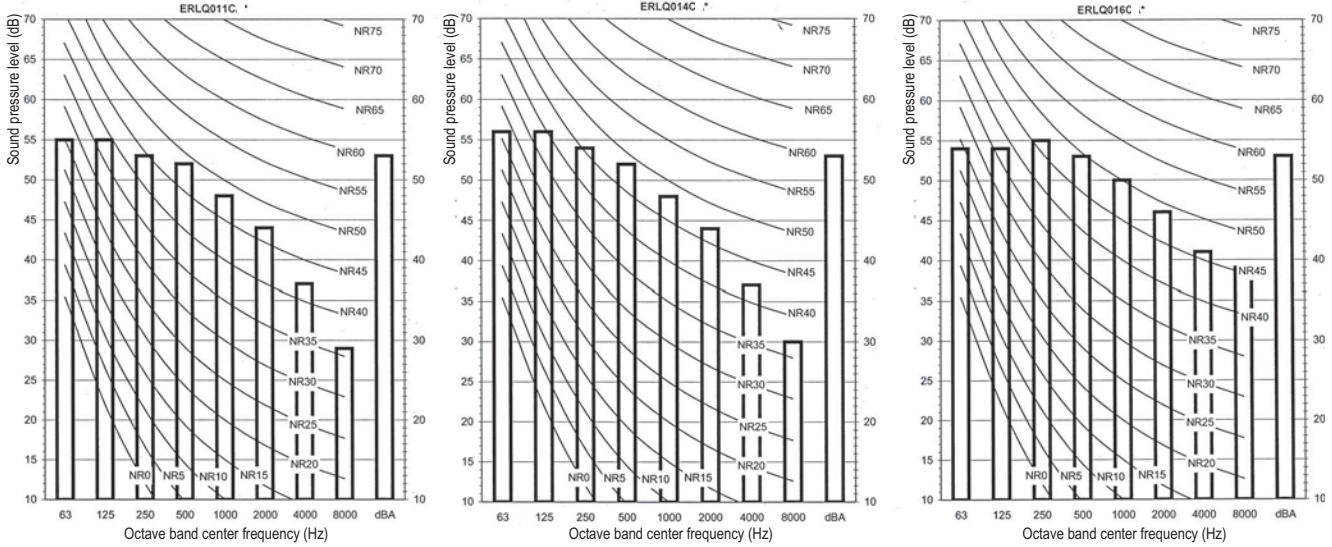

NOTES

- 1 Data is valid at free field condition (measured in a semi-anechoic room).
- 2 dBA = A-weighted sound pressure level. (A-scale according to IEC)
- 3 Reference acoustic pressure 0dB = 20μPa.
- 4 If the sound is measured under actual installation conditions, the measured value will be higher due to environmental noise and sound reflections.
- 5 Data is valid at nominal capacity

Measuring location (discharge side):

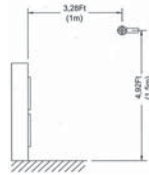

3TW60337-2

9 Sound data

9 - 2 Sound Pressure Spectrum - Cooling

9

Cooling

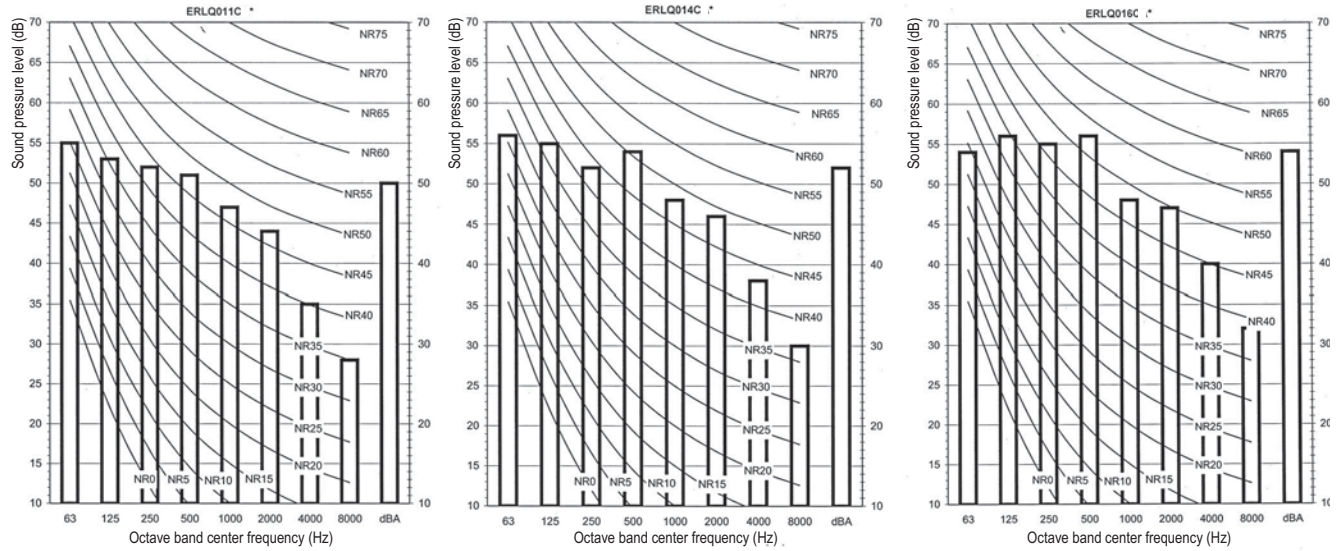

NOTES

- 1 Data is valid at free field condition (measured in a semi-anchoic room).
- 2 dBA = A-weighted sound pressure level. (A-scale according to IEC)
- 3 Reference acoustic pressure 0dB = 20μPa.
- 4 If the sound is measured under actual installation conditions, the measured value will be higher due to environmental noise and sound reflections.
- 5 Data is valid at nominal capacity

Measuring location (discharge side):

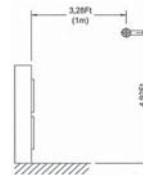

3TW60337-1

9 Sound data

9 - 3 Sound Pressure Spectrum Quiet Mode

Heating

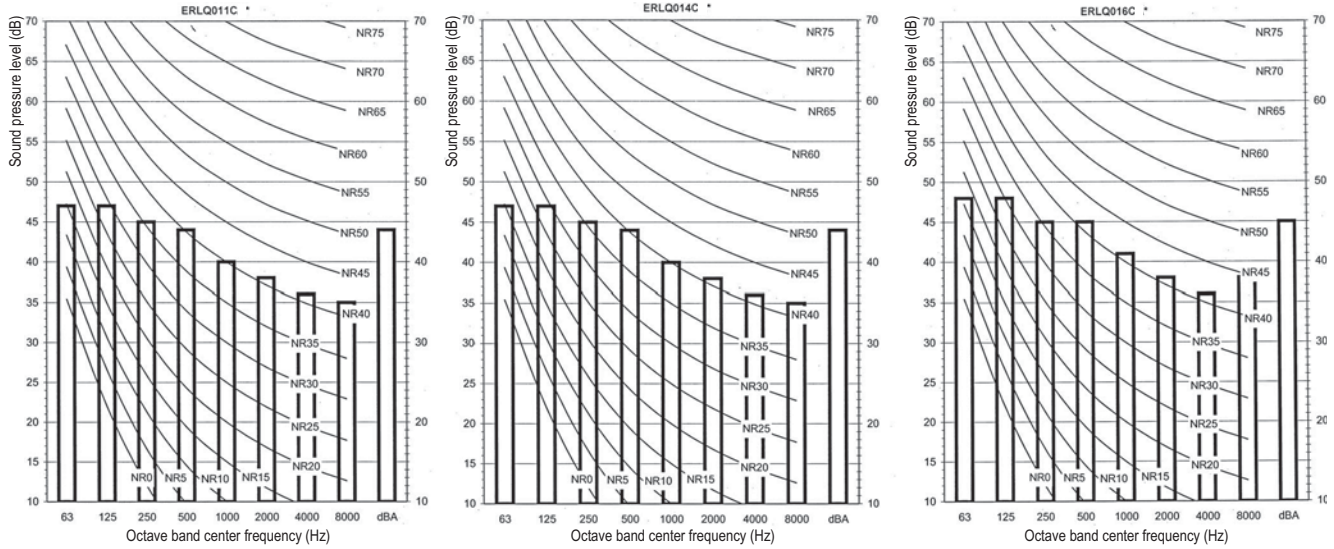

NOTES

- 1 Data is valid at free field condition (measured in a semi-anechoic room).
- 2 dBA = A-weighted sound pressure level. (A-scale according to IEC)
- 3 Reference acoustic pressure 0dB = 20μPa.
- 4 If the sound is measured under actual installation conditions, the measured value will be higher due to environmental noise and sound reflections.
- 5 Data is valid at night quiet mode level 2

Measuring location (discharge side):

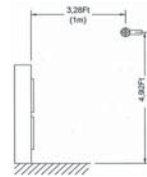

3TW60337-4

Cooling

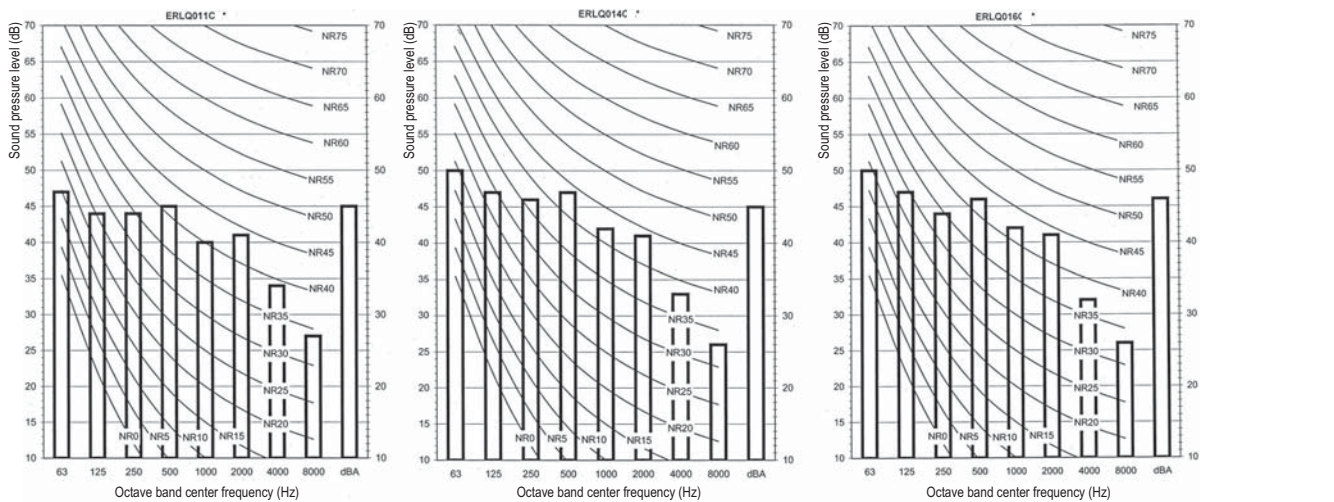

NOTES

- 1 Data is valid at free field condition (measured in a semi-anechoic room).
- 2 dBA = A-weighted sound pressure level. (A-scale according to IEC)
- 3 Reference acoustic pressure 0dB = 20μPa.
- 4 If the sound is measured under actual installation conditions, the measured value will be higher due to environmental noise and sound reflections.
- 5 Data is valid at night quiet mode level 2

Measuring location (discharge side):

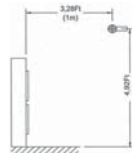

3TW60337-3

10 Installation

10 - 1 Installation Method

10

ERLQ011-016C

Installation servicing space

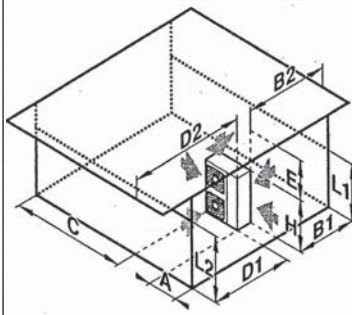

←	↗	↘	↖	↓	A	B1	B2	C	D1	D2	E	L1/L2
✓						≥200						
✓		✓	✓		≥200	≥200		≥200				
✓				✓		≥200				≥500	≥1000	
✓	✓	✓	✓	✓	≥300	≥300		≥300		≥500	≥1000	1
✓	✓								≥500			
✓			✓				≥500		≥500		≥1000	
✓	✓				L1<L2	≥200			≥500			
					L2<L1	≥200			≥500			
✓					L1<L2	≥350	≥500		≥750		≥1000	0<L1≤1/2H
				H<L1	L1≤H			≥1000		0<L1≤1/2H		
✓	✓			✓	L2<L1	≥200			≥1000	≥500	≥1000	0<L2≤1/2H
					H<L2	≥300			L2≤H			1/2H<L2≤H
												2

NOTES

Legend (Unit: mm)

- ← Suction side obstacle
- ↗ Discharge side obstacle
- ↘ Left side obstacle
- ↖ Right side obstacle
- ↓ Top side obstacle
- ✓ Obstacle is present
- ☐ This situation is not allowed

- 1 Recommended installation set-up for the ERLQ011~016*
(to prevent exposure to wind or that the heat exchanger coil is affected by snow)
- 2 In these cases, close bottom of the installation frame to prevent discharged air from being bypassed

10 Installation

10 - 1 Installation Method

ERLQ011-016C

Installation guidelines / precautions Daikin Altherma

Outdoor unit

Installation location (general)

Select an installation site that meets the following requirements:

- The foundation must be strong enough to support the weight of the unit. The floor is flat to prevent vibrations and noise generation and to have sufficient stability.
- The space around the unit is adequate for maintenance/servicing and allows for sufficient air circulation. (Refer to "Installation and service space" information sheet)
- There is no danger of fire due to leakage of inflammable gas.
- The equipment is not intended for use in a potentially explosive atmosphere.
- Select the location of the unit in such a way that the sound and discharged cold/hot air generated by the unit does not disturb anyone, and the location is selected according the applicable legislation.
- All piping lengths and distances have been taken into consideration (refer to "Technical specification" information sheet).
- Take care that in the event of a water leak, water cannot cause any damage to the installation space and surroundings.
- Install units, power cords and inter-unit cables at least 3 m away from television and radio sets. This is to prevent interference to images and sounds.
- Depending on radio wave conditions, electromagnetic interference may still occur even if installed more than 3 m away.

Do not install in the following locations:

- Locations where sulphurous acids and other corrosive gases may be present in the atmosphere.
- Locations where a mineral oil mist, spray or vapour may be present in the atmosphere.
- Locations where flammable gases may leak, where thinner, gasoline and other volatile substances are handled, or where carbon dust and other incendiary substances are found in the atmosphere.
- In areas where the air contains high levels of salt such as that near the ocean.
- To prevent exposure to wind, install the outdoor unit with its suction side facing the wall.
- Never install the outdoor unit at a site where the suction side (left and back) may be exposed directly to wind, snow. (See "Installation and Service space" information sheet and figure 1)

Installation location (in cold climates)

- To prevent exposure to wind, install a baffle plate on the air discharge side of the outdoor unit.
- Unit should be installed in a way that a minimum of 10 cm free space is assured below the unit's bottom plate at all conditions (prevent burying in snow), e.g.: heavy snowfall (if necessary construct a pedestal).
- In heavy snowfall areas it is very important to select an installation site where the snow will not affect the unit. Make sure that the heat exchanger coil (left and back side) is not affected by the snow (if necessary construct a lateral canopy and baffle plate on the air side).
- Recommended installation set-up. (See "Installation and Service space" information sheet and figure 2)

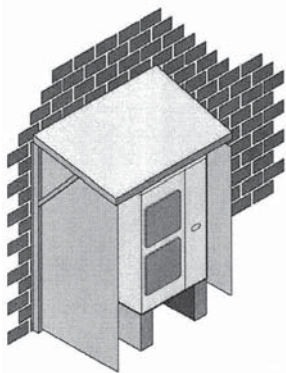

Figure 1: construction to prevent exposure to wind and snow

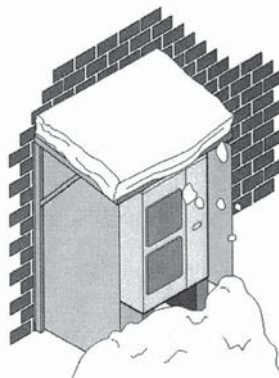

Figure 2: construction to prevent affect of snow to the unit

4TW60339-2

11 Operation range

11 - 1 Operation Range

11

ERLQ-CW1

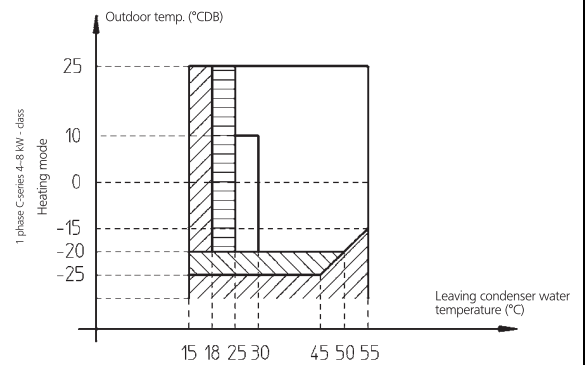
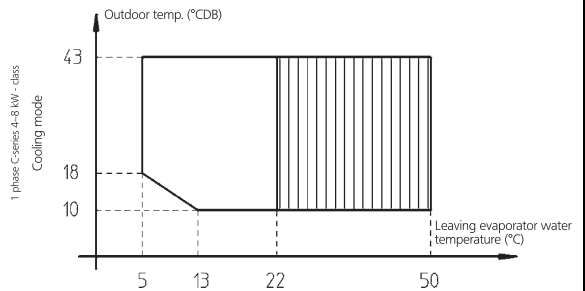
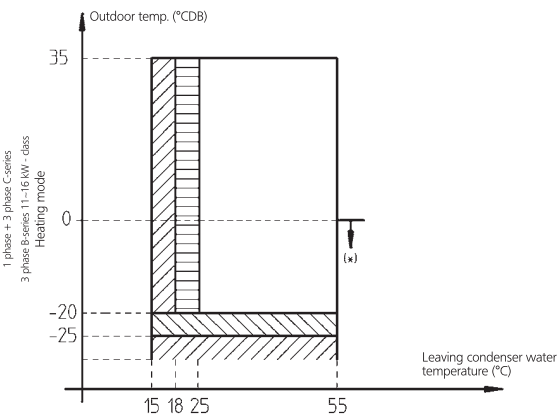
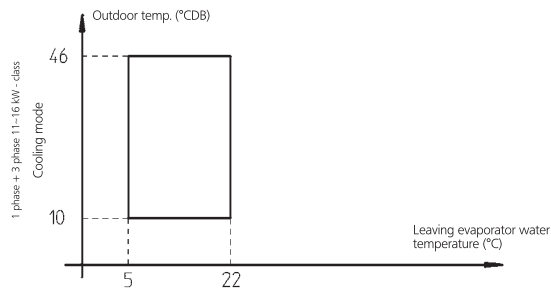

- LEGEND:
- : Only backup heater operation (no outdoor unit operation)
 - : Outdoor unit operation if setpoint $\geq 25^{\circ}\text{C}$
 - : Operation of outdoor unit possible, but no guarantee of capacity (if outdoor temperature $< -20^{\circ}\text{C}$ or $< -25^{\circ}\text{C}$ outdoor unit will stop) (indoor unit and backup heater operation will continue)
 - : Pull down area

Remark: for restricted power supply condition mode outdoor unit, booster heater and back-up heater can operate separately.

(*) *RLQ units include special equipment (insulation, heater sheet, ...) to ensure good operation in areas where low ambient temperature can occur together with high humidity conditions. In such conditions the *RLQ models may experience problems with severe ice build up on the aircooled coil. In case such conditions are expected, the *RLQ must be installed instead. These models contain countermeasures (insulation, heater sheet, ...) to prevent freeze up.

3TW60813-1A

11 Operation range

11 - 1 Operation Range

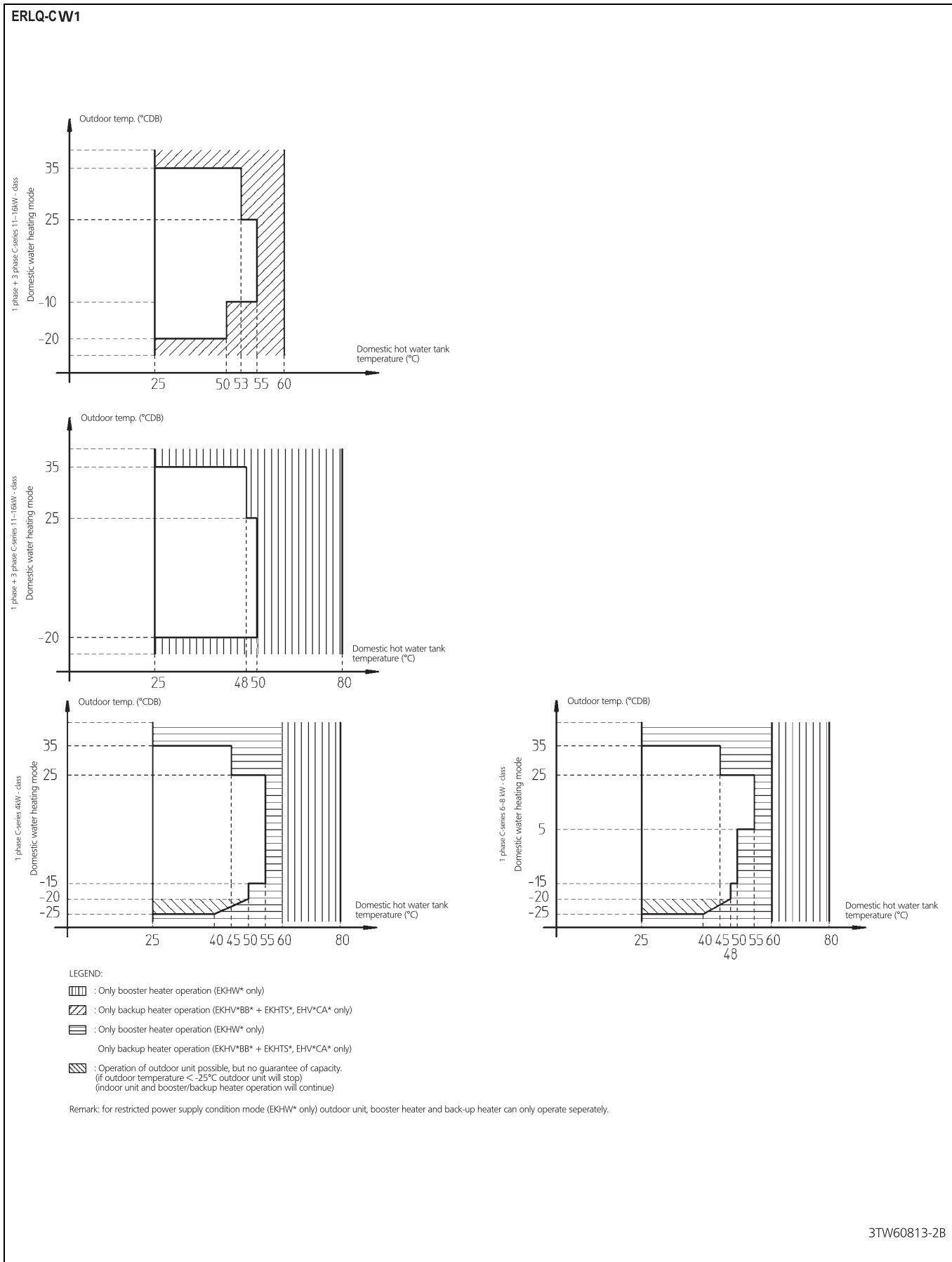



Daikin's unique position as a manufacturer of air conditioning equipment, compressors and refrigerants has led to its close involvement in environmental issues. For several years Daikin has had the intention to become a leader in the provision of products that have limited impact on the environment. This challenge demands the eco design and development of a wide range of products and an energy management system, resulting in energy conservation and a reduction of waste.



Daikin Europe N.V. participates in the Eurovent Certification programme for Air conditioners (AC), Liquid Chilling Packages (LCP) and Fan coil units (FCU). Check on-going validity of certificate online: www.eurovent-certification.com or using: www.certiflash.com

The present leaflet is drawn up by way of information only and does not constitute an offer binding upon Daikin Europe N.V.. Daikin Europe N.V. has compiled the content of this leaflet to the best of its knowledge. No express or implied warranty is given for the completeness, accuracy, reliability or fitness for particular purpose of its content and the products and services presented therein. Specifications are subject to change without prior notice. Daikin Europe N.V. explicitly rejects any liability for any direct or indirect damage, in the broadest sense, arising from or related to the use and/or interpretation of this leaflet. All content is copyrighted by Daikin Europe N.V.

BARCODE

Daikin products are distributed by:

